

**ebm-papst St. Georgen GmbH & Co. KG**

Hermann-Papst-Str. 1  
 D-78112 St. Georgen  
 Phone +49 (0) 7724 81-0  
 Fax +49 (0) 7724 81-1309  
 sales@fansco.com  
 www.fansco.com

## Nominal data

Type	RL 48-19/12 ML	
Nominal voltage	VDC	12
Nominal voltage range	VDC	8 .. 15
Speed (rpm)	min <sup>-1</sup>	3500
Power consumption	W	5.0
Min. ambient temperature	°C	-20
Max. ambient temperature	°C	70
Air flow	m <sup>3</sup> /h	22
Sound power level	B	5.3

ml = Max. load · me = Max. efficiency · fa = Free air · cs = Customer specification · ce = Customer equipment  
 Subject to change



## Technical description

<b>General description</b>	Forward-curved impeller
<b>Weight</b>	0.075 kg
<b>Dimensions</b>	76 x 76 x 27 mm
<b>Impeller material</b>	Glass-fiber reinforced plastic
<b>Housing material</b>	Scroll housing made of glass-fiber reinforced plastic.
<b>Airflow direction</b>	Axial intake, radial discharge from outlet.
<b>Storage</b>	Ball bearing
<b>Service life L10 at 40 °C</b>	70000 h
<b>Service life L10 at maximum temperature</b>	35000 h
<b>Cable</b>	With leads AWG 26, TR 64
<b>Motor protection</b>	Protection against reverse polarity and blocked rotor.
<b>Locked-rotor protection</b>	Electronic locked-rotor protection
<b>Approval</b>	VDE, CSA, UL, CE



## Product drawing

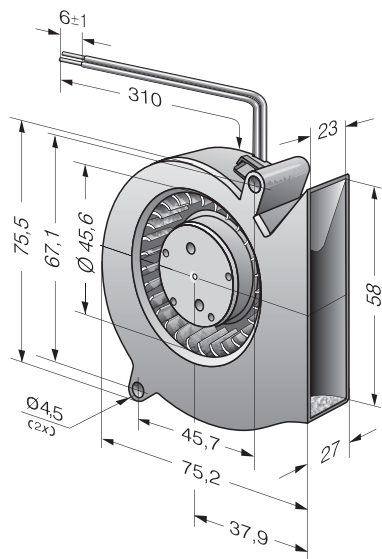

## Curves

