

**ebm-papst St. Georgen GmbH & Co. KG**

Hermann-Papst-Str. 1

D-78112 St. Georgen

Phone +49 (0) 7724 81-0

Fax +49 (0) 7724 81-1309

sales@fansco.com

www.fansco.com

Nominal data

Type	RER 175-42/18/2 TDMP	
Nominal voltage	VDC	48
Nominal voltage range	VDC	36 .. 72
Speed (rpm)	min ⁻¹	4800
Power consumption	W	110
Min. ambient temperature	°C	-20
Max. ambient temperature	°C	65
Air flow	m ³ /h	865
Sound power level	B	8.2

ml = Max. load · me = Max. efficiency · fa = Free air · cs = Customer specification · ce = Customer equipment
Subject to change



Technical description

General description	3-phase fan drive with very smooth operation and high efficiency Backward-curved impeller
Impeller material	Glass-fiber reinforced plastic
Weight	0.775 kg
Dimensions	Ø 175 x 69 mm
Airflow direction	Axial: intake, radial: discharge
Direction of rotation	Clockwise, viewed toward rotor
Storage	Ball bearing
Service life L10 at 40 °C	70000 h
Service life L10 at maximum temperature	40000 h
Cable	With leads AWG 18, 20 or AWG 22, TR 64, speed signal and control input AWG 22



Product drawing

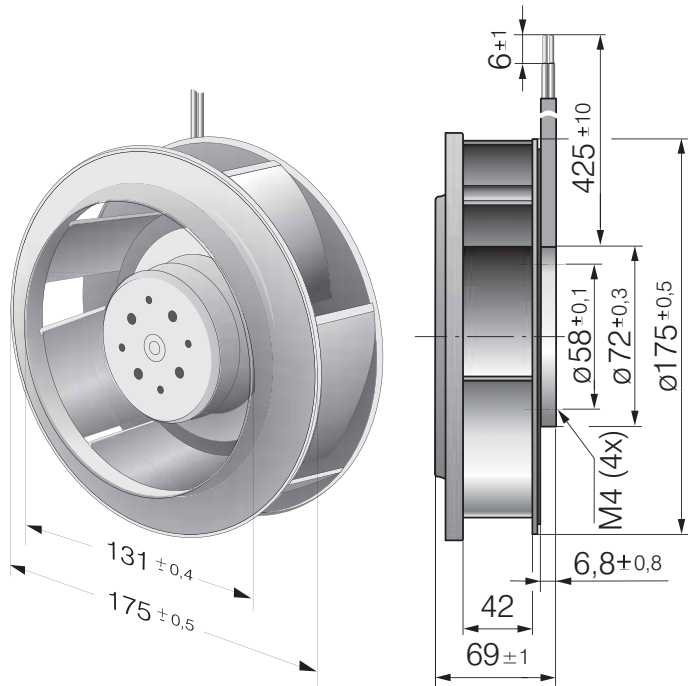

Curves

