

G1G108-AB17-02

EC centrifugal fan

forward-curved, single-intake
with housing (flange)



ebm-papst Mulfingen GmbH & Co. KG

Bachmühle 2 · D-74673 Mulfingen

Phone +49 7938 81-0

Fax +49 7938 81-110

sales@fansco.com

www.fansco.com

Limited partnership · Headquarters Mulfingen

Amtsgericht (court of registration) Stuttgart · HRA 590344

General partner Elektrobau Mulfingen GmbH · Headquarters Mulfingen

Amtsgericht (court of registration) Stuttgart · HRB 590142

Nominal data

Type	G1G108-AB17-02	
Motor	M1G055-BD	
Nominal voltage	VDC	24
Nominal voltage range	VDC	16 .. 28
Frequency	Hz	-
Method of obtaining data		fa
Speed (rpm)	min ⁻¹	3000
Power consumption	W	42
Current draw	A	2.0
Min. ambient temperature	°C	-25
Max. ambient temperature	°C	60

ml = Max. load · me = Max. efficiency · fa = Free air · cs = Customer specification · ce = Customer equipment
Subject to change



EC centrifugal fan

forward-curved, single-intake
with housing (flange)

Technical description

Weight	1.4 kg
Size	108 mm
Motor size	55
Rotor surface	Painted black
Electronics housing material	Die-cast aluminum
Impeller material	Sheet steel, hot-dip galvanized
Housing material	Die-cast aluminum
Direction of rotation	Clockwise, viewed toward rotor
Degree of protection	IP22
Insulation class	"B"
Moisture (F) / Environmental (H) protection class	F0; H0 - dry environment
Max. permitted ambient temp. for motor (transport/storage)	+ 80 °C
Min. permitted ambient temp. for motor (transport/storage)	- 40 °C
Installation position	Any
Condensation drainage holes	None
Mode	S1
Motor bearing	Ball bearing
Technical features	<ul style="list-style-type: none"> - Tach output - Motor current limitation - Soft start - Control input 0-10 VDC / PWM
EMC immunity to interference	According to EN 61000-6-2 (industrial environment)
EMC interference emission	According to EN 61000-6-3 (household environment)
Motor protection	Reverse polarity and locked-rotor protection
With cable	Axial
Conformity with standards	EN 60950-1
Approval	UL 1004-1; CSA C22.2 No. 77; EAC



G1G108-AB17-02

EC centrifugal fan

forward-curved, single-intake
with housing (flange)

Product drawing

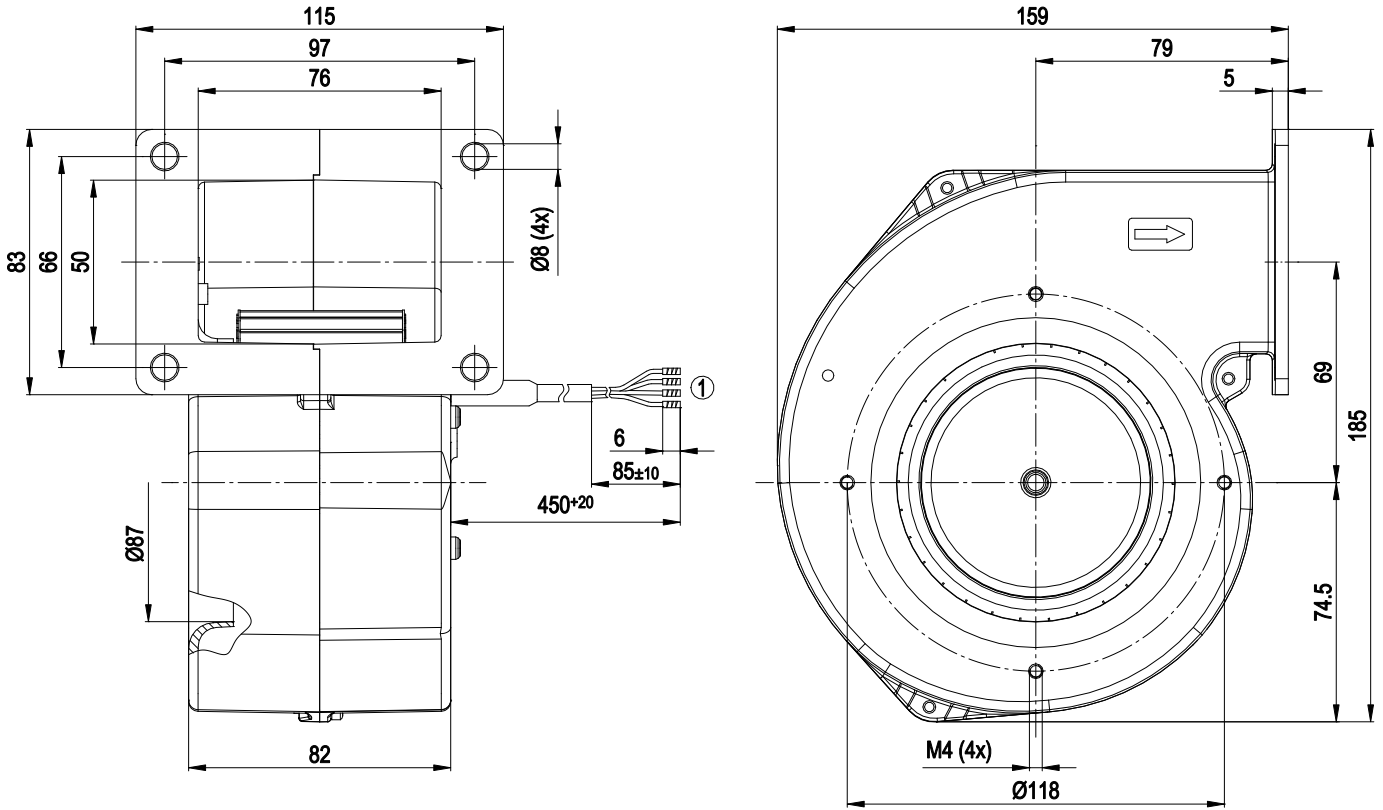

1 Cable PVC AWG20, 4x crimped splices



EC centrifugal fan

forward-curved, single-intake
with housing (flange)

Connection diagram

Customer circuit

Full speed

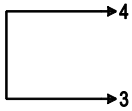

Adjustable speed

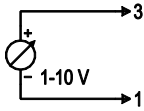

10 V → n = max
1 V → n = min
< 1 V → n = 0
Safe start at Unom -30% from 4 V Ucontr.

Speed adjustable with fixed resistor

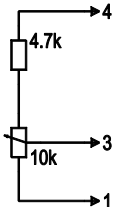

Speed adjustable via PWM 1-10 kHz

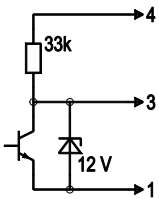

100% PWM → n = max
10% PWM → n = min
< 10% PWM → n = 0
Safe start at Unom -30% from 40% PWM

Set value requirement via temperature controller

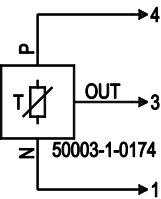

Connection

Fan / Motor

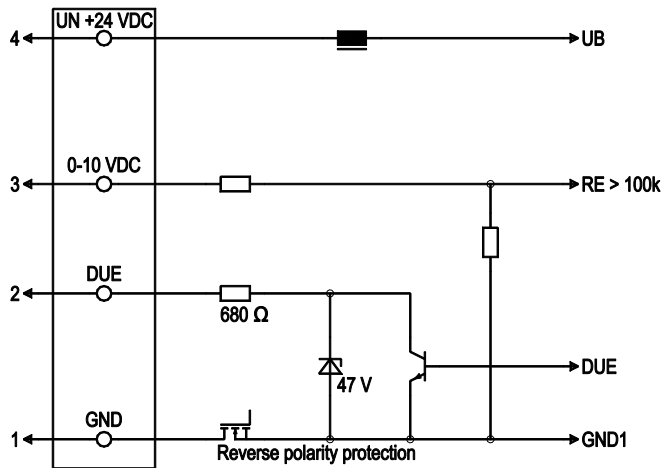

No.	Conn.	Designation	Color	Function/assignment
1	1	GND	blue	Reference ground
1	2	Tach	white	Tach output, 2 pulses per revolution, Isink max = 10 mA
1	3	0-10 VDC	yellow	Control input Re > 100k
1	4	Un +24 VDC	red	Power supply 24 VDC, maximum ripple 3.5%



Curves: Air performance

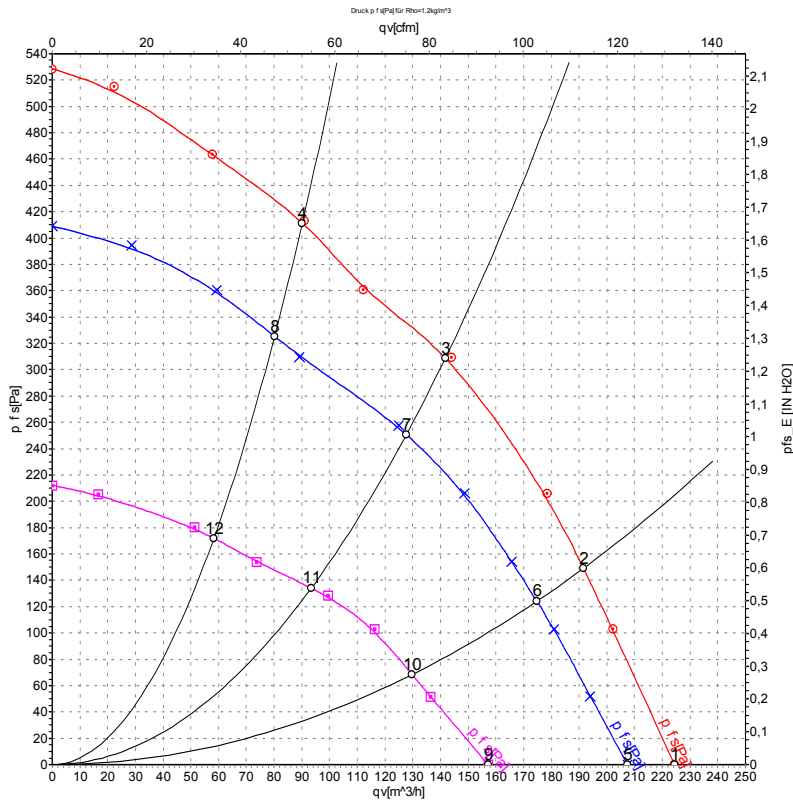

Measurement: LU-47851-1
Measurement: LU-47850-1
Measurement: LU-47852-1

Air performance measured according to ISO 5801 installation category A. For detailed information on the measurement setup, contact ebm-papst. Intake sound level: Sound power level according to ISO 13347 / sound pressure level measured at 1 m distance from fan axis. The values given are valid under the specified measuring conditions and may vary due to conditions of installation. For deviations from the standard configuration, the parameters have to be checked on the installed unit.

Measured values

	U	n	P _{ed}	I	q _v	p _{fs}	q _v	p _{fs}
	V	min ⁻¹	W	A	m ³ /h	Pa	cfm	in. wg
1	28	3235	55	2.26	225	0	130	0.00
2	28	3480	51	2.06	190	149	115	0.60
3	28	3800	44	1.76	140	313	85	1.26
4	28	4055	38	1.49	90	414	55	1.66
5	24	3000	42	2.00	205	0	120	0.00
6	24	3170	39	1.80	175	125	105	0.50
7	24	3415	33	1.50	130	250	75	1.00
8	24	3625	28	1.28	80	325	45	1.30
9	16	2290	19	1.33	155	0	90	0.00
10	16	2400	17	1.19	130	68	75	0.27
11	16	2540	14	1.00	95	134	55	0.54
12	16	2670	12	0.88	60	172	35	0.69

U = Voltage · n = Speed (rpm) · P_{ed} = Power consumption · I = Current draw · q_v = Air flow · p_{fs} = Pressure increase

