

**ebm-papst St. Georgen GmbH & Co. KG**

Hermann-Papst-Str. 1

D-78112 St. Georgen

Phone +49 (0) 7724 81-0

Fax +49 (0) 7724 81-1309

sales@fansco.com

www.fansco.com

**Nominal data**

Type	8500 N	
Phase		1~
Nominal voltage	VAC	115
Frequency	Hz	60
Speed (rpm)	min <sup>-1</sup>	3200
Power consumption	W	11.0
Min. ambient temperature	°C	-10
Max. ambient temperature	°C	75
Air flow	m <sup>3</sup> /h	61
Sound power level	B	4.8
Sound pressure level	dB(A)	34

ml = Max. load · me = Max. efficiency · fa = Free air · cs = Customer specification · ce = Customer equipment  
Subject to change



**Technical description**

<b>Weight</b>	0.490 kg
<b>Dimensions</b>	80 x 80 x 38 mm
<b>Impeller material</b>	Sheet steel, painted black
<b>Housing material</b>	Die-cast aluminum
<b>Part no.</b>	9274014207
<b>Airflow direction</b>	Exhaust over struts
<b>Direction of rotation</b>	Clockwise, viewed toward rotor
<b>Storage</b>	Sintec sleeve bearing
<b>Service life L10 at 40 °C</b>	55000 h
<b>Service life L10 at maximum temperature</b>	25000 h
<b>Cable</b>	With 2 leads AWG 18, TR 64 Grounding lug M4 x 8
<b>Motor protection</b>	Protected from overload by impedance protection
<b>Approval</b>	VDE, CSA, UL, CE



## Product drawing

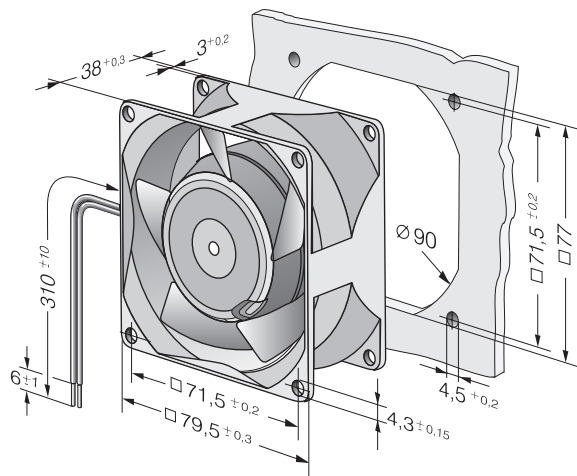

## Curves: Air performance

