

Product Data Sheet

8315100138

VWC0080KUFCS

**ebmpapst**

The engineer's choice



INDEX

- 1 General ..... 3**
- 2 Mechanics ..... 3**
  - 2.1 General ..... 3
  - 2.2 Connections ..... 3
- 3 Operating Data ..... 4**
  - 3.1 Electrical Interface - Input ..... 4
  - 3.2 Electrical Operating Data ..... 5
  - 3.3 Electrical Interface - Output ..... 6
  - 3.4 Electrical Features ..... 7
  - 3.5 Aerodynamics ..... 8
  - 3.6 Sound Data ..... 9
- 4 Environment ..... 9**
  - 4.1 General ..... 9
  - 4.2 Climatic Requirements ..... 9
  - 4.3 EMC ..... 9
- 5 Safety ..... 10**
  - 5.1 Electrical Safety ..... 10
  - 5.2 Approval Tests ..... 10
- 6 Reliability ..... 10**
  - 6.1 General ..... 10

**1 General**

Fan type	Fan	
Rotating direction looking at rotor	Counterclockwise	
Airflow direction	Air outlet over struts	
Bearing system	Ball bearing	
Mounting position - shaft	Any	

**2 Mechanics**

**2.1 General**

Width	80,0 mm	
Height	80,0 mm	
Depth	38,0 mm	
Mass	0,220 kg	
Housing material	Plastic	
Impeller material	Plastic	
Max. torque when mounted across both mounting flanges	Wire outlet corner: 50 Ncm Remaining corners: 110 Ncm	
Screw size	ISO 4762 - M4 degreased, without an additional brace and without washer	

**2.2 Connections**

Electrical connection	Wires	
Lead wire length	L = 310 mm	
Tolerance	+ - 10,0 mm	
Wire size (AWG)	22	
Insulation diameter	1,70 mm	

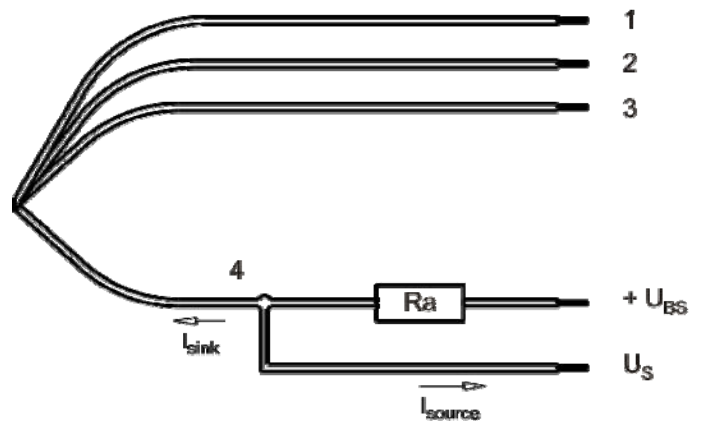

Wire	Color	Operation	Wire size	Insulation diameter
1	red	+ UB	AWG 22	1,70 mm
2	blue	- GND	AWG 22	1,70 mm
3	violet	PWM	AWG 22	1,70 mm
4	white	Tacho	AWG 22	1,70 mm

The auxiliaries shown on the schematic diagram (which are required for the intended use) are not part of our delivery.

3 Operating Data

3.1 Electrical Interface - Input

Control input	PWM
---------------	-----

Features

Input type	Open collector	
PWM - Frequency		1 kHz - 10 kHz typical: 2 kHz

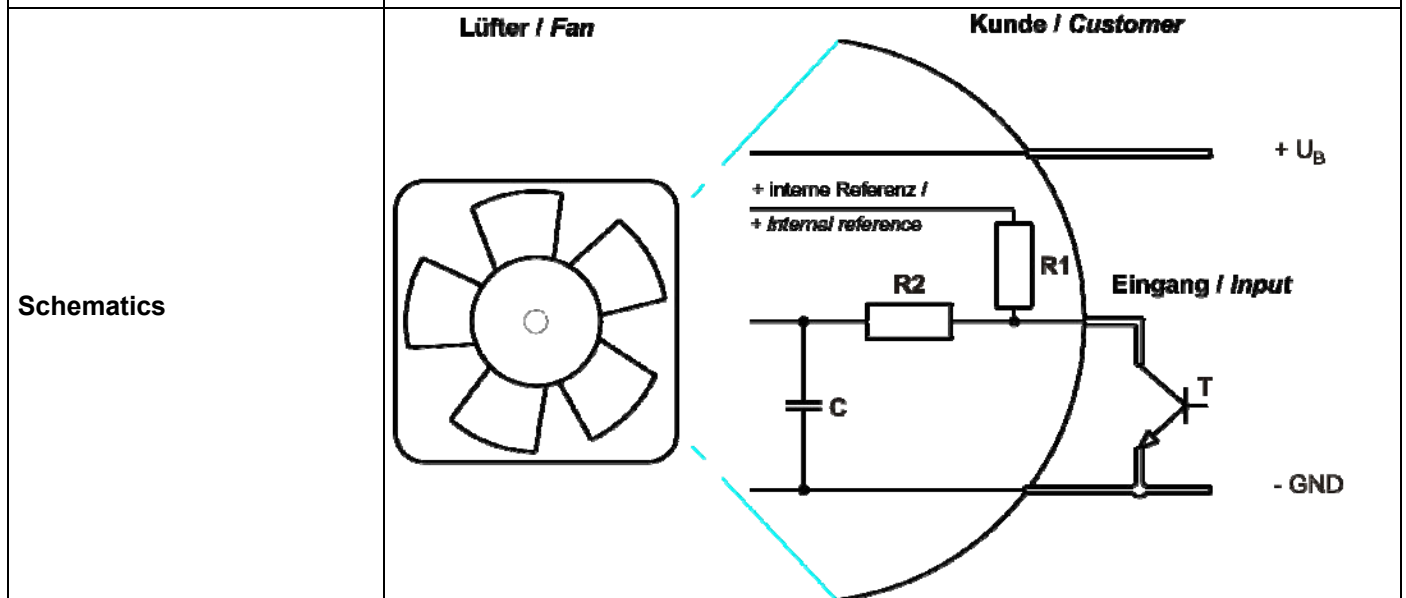
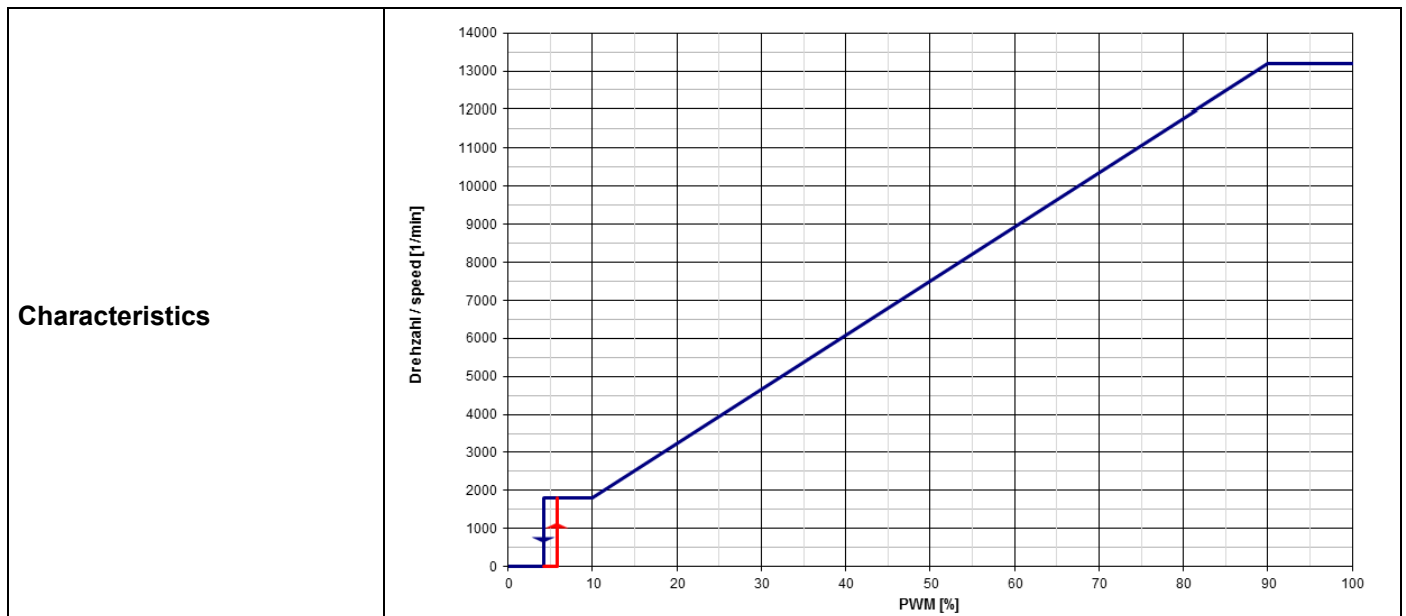

Speed controll: 0... 100 %, PWM-Low < 0,2 V

### 3.2 Electrical Operating Data

Measurement conditions: Normal air density = 1,2 kg/m<sup>3</sup>; Temperature 23°C +/- 3°C; Motor axis horizontal; warm-up time before measuring 5 minutes (unless otherwise specified). In the intake and outlet area should not be any solid obstruction within 0,5 m.

$\Delta p = 0$ : corresp. to free air flow (see chapter aerodynamics)  
I: corresp. to arithm. mean current value

Name	Condition
PWM 0001	PWM: 100 %; f: 2 kHz

Features	Condition	Symbol	Values		
Voltage range		U	36 V		60 V
Nominal voltage		U <sub>N</sub>		48 V	
Power consumption	$\Delta p = 0$	P	25 W	25 W	25 W
Tolerance	PWM 0010		+/- 17,5 %	+/- 17,5 %	+/- 17,5 %
Current consumption	$\Delta p = 0$	I	700 mA	520 mA	430 mA
Tolerance	PWM 0010		+/- 17,5 %	+/- 17,5 %	+/- 25,0 %
Speed	$\Delta p = 0$	n	13.200 1/min	13.200 1/min	13.200 1/min
Tolerance	PWM 0010		+/- 12,5 %	+/- 5 %	+/- 5 %
Starting current consumption				2.300 mA	

3.3 Electrical Interface - Output

Tacho type	/2 (open collector)
------------	---------------------

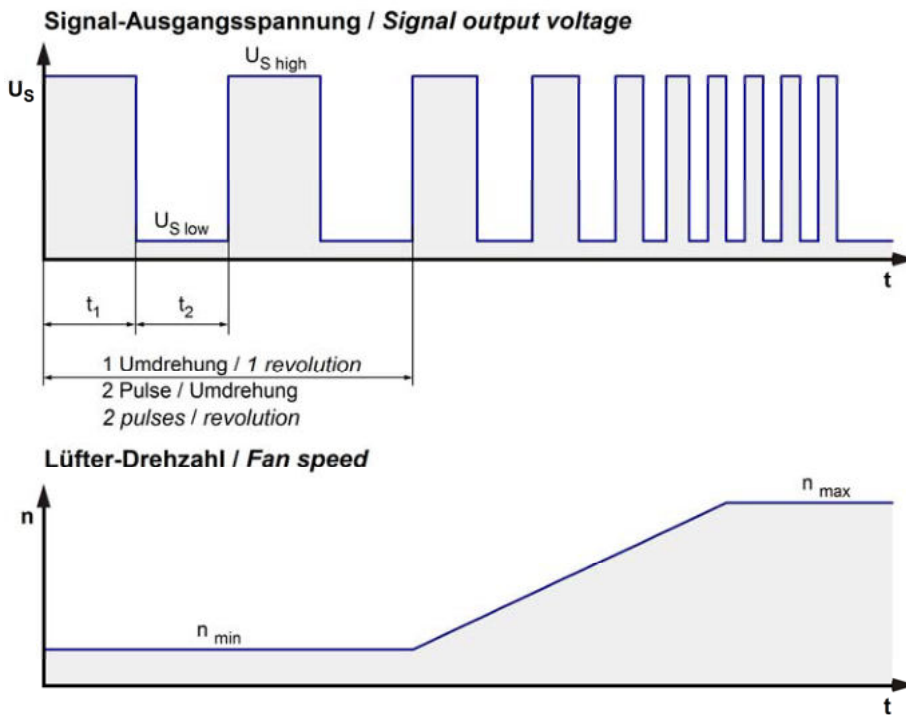

$$R_a = \frac{U_{BS} - U_{S\ low}}{I_{sink}}$$

Lüfter / Fan      Kunde / Customer

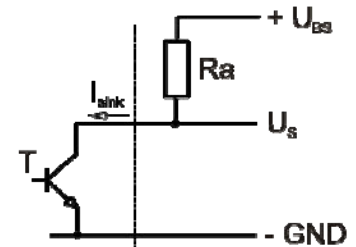

Features	Note	Values
Tacho operating voltage	$U_{BS}$	$\leq 30\text{ V}$
Tacho signal Low	$U_{S\ low}$	$\leq 0,4\text{ V}$
Tacho signal High	$U_{S\ high}$	$\leq 30\text{ V}$
Maximum sink current	$I_{sink}$	$\leq 4\text{ mA}$
External resistor	External resistor $R_a$ from $U_{BS}$ to $U_S$ required. All voltages measured to GND.	
Tacho frequency	$(2 \times n) / 60$	
Tacho isolated from motor	No	
Slew rate		$\Rightarrow 0,5\text{ V/us}$

n = revolutions per minute (1/min)

3.4 Electrical Features

Electronic function	Speed-Controlled	
Reversed polarity protection	Rectifying diode	
Max. residual current at $U_N$	$I_F \leq 100 \mu A$	
Locked rotor protection	Auto restart	
Locked rotor current at $U_N$	$I_{block}$ approx. 200 mA	
Clock signal at locked rotor	$t_3 / t_4$ typical: 2 s / 10,0 s	

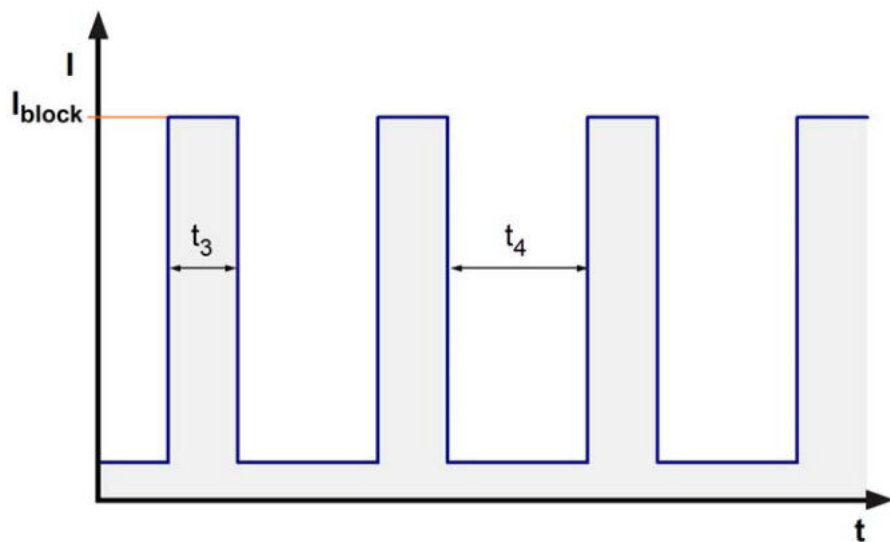

3.5 Aerodynamics

Measurement conditions: Measured with a double chamber intake rig acc. to DIN EN ISO 5801. Normal air density = 1,2 kg/m<sup>3</sup>; Temperature 23°C +/- 3°C; In the intake and outlet area should not be any solid obstruction within 0,5 m. Motor shaft horizontal.  
The information is only valid under the specified test conditions and may be changed by the installation conditions. If there are deviations from the standard test conditions, the characteristic values must be checked under the installed conditions.

a.) Operation condition:

13.200 1/min at free air flow	PWM 100 %; f: 2 kHz		
-------------------------------	---------------------	--	--

Max. free-air flow ( $\Delta p = 0 / \dot{V} = \text{max.}$ )	178 m <sup>3</sup> /h	
Max. static pressure ( $\Delta p = \text{max.} / \dot{V} = 0$ )	740 Pa	

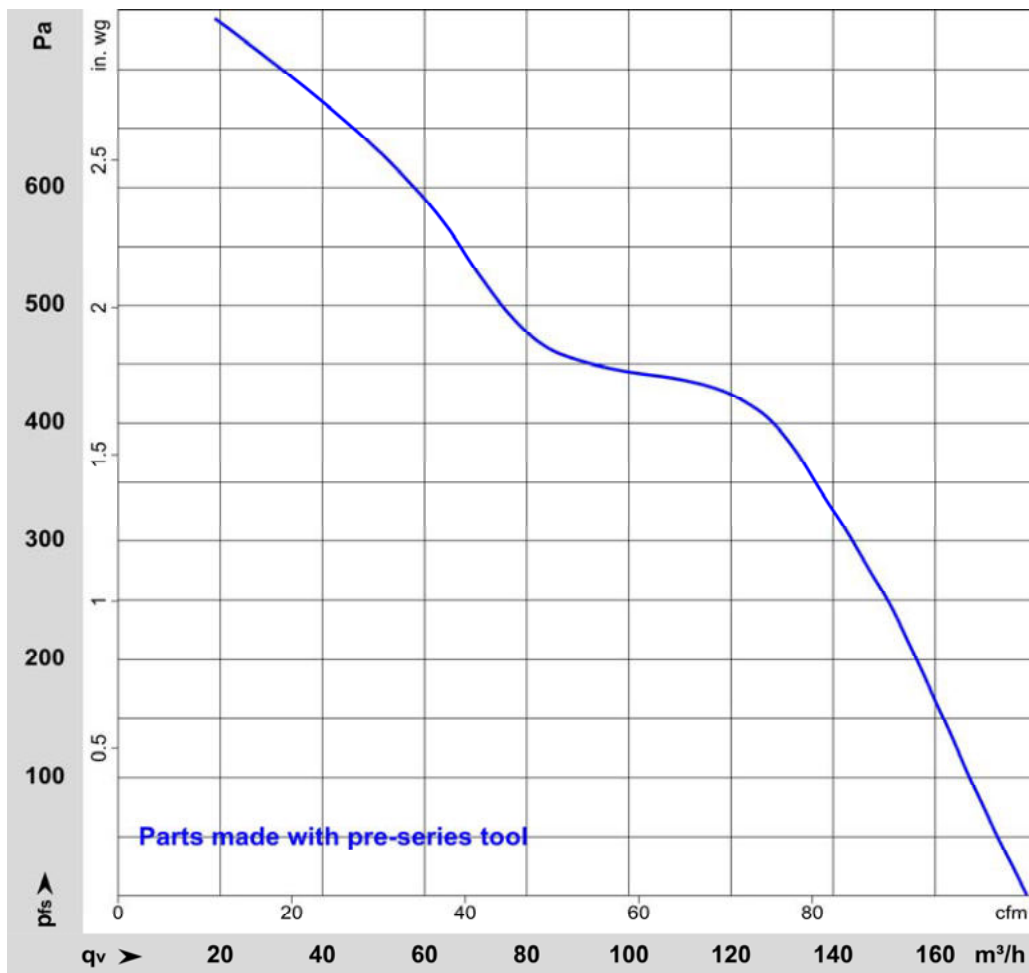



### 3.6 Sound Data

Measurement conditions: Sound pressure level: 1 meter distance between microphone and the air intake.  
Sound power level: According to ISO 13347-3.  
Measured in a semianchoic chamber with a background noise level of  $L_p(A) < 5 \text{ dB(A)}$   
For further measurement conditions see chapter aerodynamics.

a.) Operation condition:

13.200 1/min at free air flow	PWM 100 %; f: 2 kHz		
-------------------------------	---------------------	--	--

Optimal operating point	125 m <sup>3</sup> /h @ 410 Pa		
Sound power level at the optimal operating point	7,7 bel(A)		
Sound pressure level at free air flow, measured in rubber bands	71 dB(A)		

Parts made with parts with pre-series tool.

## 4 Environment

### 4.1 General

Min. permitted ambient temperature TU min.	-20 °C		
Max. permitted ambient temperature TU max.	75 °C		
Min. permitted storage temperature TL min.	-40 °C		
Max. permitted storage temperature TL max.	80 °C		

### 4.2 Climatic Requirements

Humidity requirements	humid heat, constant; according to DIN EN 60068-2-78, 14 days		
Water exposure	None		
Dust requirements	None		
Salt fog requirements	None		

Permitted application area:

The product is intended for use in sheltered rooms with controlled temperature and controlled humidity. Directly exposure to water must be avoided.

Pollution degree 1 (according DIN EN 60664-1)

There is either no pollution or it occurs only dry, non-conductive pollution. The pollution has no negative impact.

### 4.3 EMC

<b>Kind</b>	<b>Radiated Emission; 30 MHz - 1000 MHz</b>
According	DIN EN 55032:2016-02
Check accuracy / Limit	Class B
Result	Below limit Class B

<b>Kind</b>	<b>Electrostatic Discharge Immunity Test</b>
According	DIN EN 61000-4-2:2001-12
Check accuracy / Limit	Contact Discharge +/- 4 kV; Air Discharge +/- 8 kV
Result	A: The monitored function operates as designed during and after exposure to a disturbance.

**5 Safety****5.1 Electrical Safety**

Dielectric strength DIN EN 62368 and DIN EN 60335 A.) Type test Measuring conditions: After 48h of storage at 95% R.H. and 25°C. No arcing or breakdown is allowed! All connections together to ground. B.) Routine test Measuring conditions: At indoor climate. No arcing or breakdown is allowed! All connections together to ground.	500 VAC / 1 Min.  850 VDC / 1 Sec.	
Isolation resistance Measuring conditions: After 48h of storage at 95% R.H. and 25°C measured with U=500 VDC for 1 min.	RI > 10 MOhm	
Clearance / creepage distance	1,0 mm / 1,2 mm	
Protection class	III	

**5.2 Approval Tests**

CE	EC Declaration of Conformity	Yes
EAC	Eurasian Conformity	Yes
UL	Underwriters Laboratories	Yes / UL507, Electric Fans E38324
VDE	Association for Electrical, Electronic and Information Technologies	Yes / Approval acc. to EN 62368 - Audio/video, information and communication technology equipment
CSA	Canadian Standards Association	Yes / CSA audited by UL according to C22.2 No. 113 Fans and Ventilators
CCC	China Compulsory Certification	Not applicable

**6 Reliability****6.1 General**

Life expectancy L10 at TU = 40 °C	62.500 h	
Life expectancy L10 at TU max.	25.000 h	
Life expectancy L10 acc. to IPC 9591 at TU = 40 °C	105.000 h	

Copying of this document, and giving it others and the use or communication of the contents thereof, are forbidden without express authority. Offenders are liable to the payment of damages. All rights are reserved in the event of the patent or a patent or the registration of a utility model or design.

Scoutzveperk nach DIN ISO 15018 beachten!  
Refer to protection notice DIN ISO 15018!

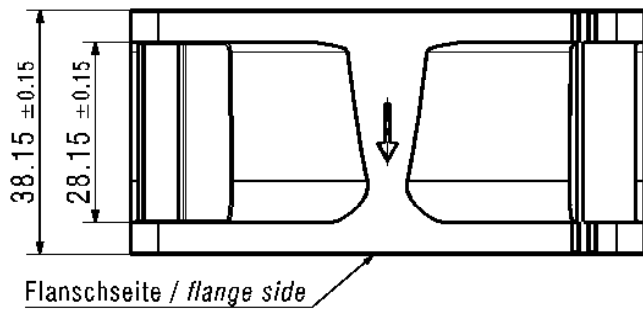
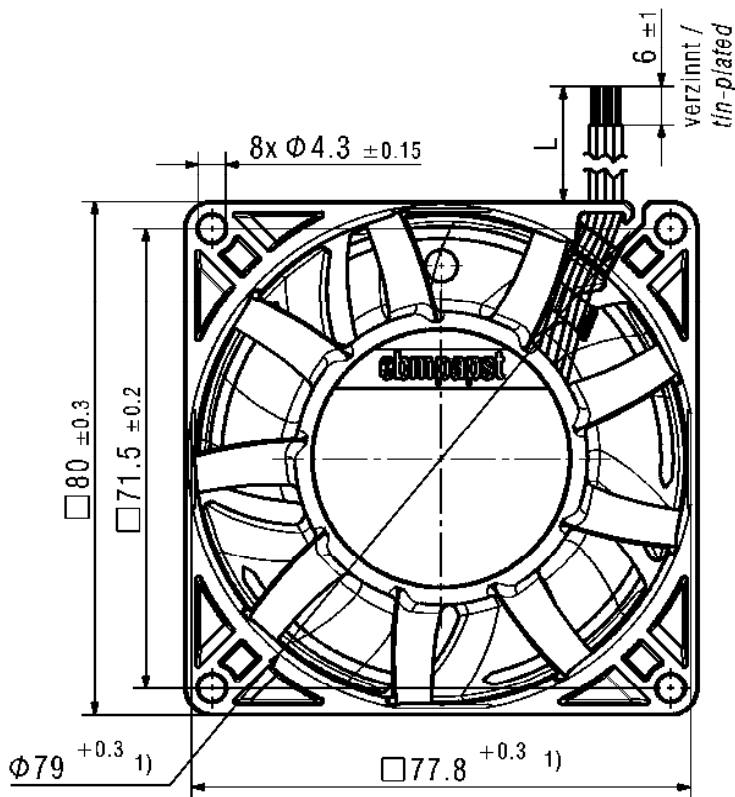
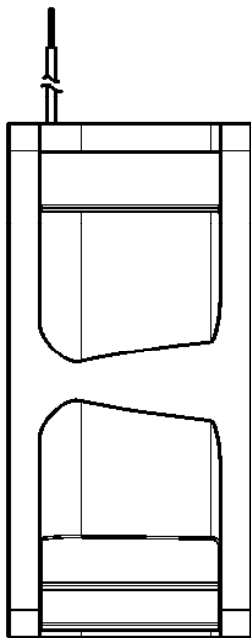

- 1) Maße für Montagewand / *Dimensions for assembly wall*  
 - Kein Axialspiel der Kugellager durch Federausgleich/  
*No axial clearance of ball bearings due to a pre-load spring*  
 - Anzahl und Länge der Litze siehe Produktspezifikation  
*Quantity and length of the wires according to design specification*

Dokument-Status / Document-Status		CATIA-Version/ CATTIA-Version	CAD-Umgebung/ CAD-Environment	Werkstoff / Material:	Volumen / Volume (mm <sup>3</sup> ):
	Aend.-Nr./ Change-No.	8315100134 CPE000		Titel / Title:	Gewicht / Mass (g):
		3D-Referenzmodell / 3D-Reference Model			
Tolerierung / Tolerances:		Datum		Zchg.-Nr. / Drawing No:	
Allgemeintoleranzen / Gen. Tolerances:		Bearb./ Drawn	Name	Ers.f.Zchg. / Replaces:	
		Gepr./ Checked			
		Freig./ Released			
		<b>ebmpapst</b>		Dokumenttyp / Type of Document	Teildokument (Blatt/Page)
		ebm-papst St. Georgen GmbH & Co KG		Index / Index	Format / Size:
					Messstab/Scale