

## Nominal data

Type 7806 ES

Phase		1~
Nominal voltage	VAC	115
Frequency	Hz	60
Speed	min <sup>-1</sup>	3250
Power input	W	38.0
Min. ambient temperature	°C	-25
Max. ambient temperature	°C	90
Air flow	m <sup>3</sup> /h	380
Sound power level	B	6.4
Sound pressure level	dB(A)	53

ml = Max. load · me = Max. efficiency · fa = Running at free air · cs = Customer specs · cu = Customer unit  
Subject to alterations

**Technical features**

<b>Mass</b>	1.1 kg
<b>Dimensions</b>	150 Ø x 55 mm
<b>Material of impeller</b>	Sheet steel, coated in black
<b>Housing material</b>	Die-cast aluminium
<b>Direction of air flow</b>	Exhaust over struts
<b>Direction of rotation</b>	Left, looking at rotor
<b>Bearing</b>	Ball bearings
<b>Lifetime L10 at 40 °C</b>	60000 h
<b>Lifetime L10 at maximum temperature</b>	15000 h
<b>Connection line</b>	With 2 single strands. Strand ends with lead tips. Grounding lug for M4 x 8.
<b>Motor protection</b>	Protected from overload by a thermal switch
<b>Approval</b>	VDE, CSA, UL, CE

7806 ES

# AC axial compact fan

## Product drawing

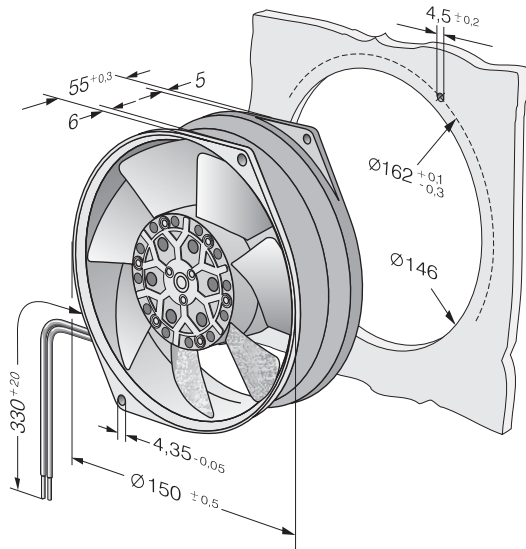

## Charts: Air flow

