

7112 N

# DC axial compact fan



## ebm-papst St. Georgen GmbH & Co. KG

Hermann-Papst-Str. 1  
D-78112 St. Georgen  
Phone +49 (0) 7724 81-0  
Fax +49 (0) 7724 81-1309  
sales@fansco.com  
www.fansco.com

### Nominal data

Type	7112 N	
Nominal voltage	VDC	12
Nominal voltage range	VDC	6 .. 15
Speed (rpm)	min <sup>-1</sup>	2850
Power consumption	W	12.0
Min. ambient temperature	°C	-25
Max. ambient temperature	°C	72
Air flow	m <sup>3</sup> /h	308
Sound power level	B	6.2
Sound pressure level	dB(A)	53

ml = Max. load · me = Max. efficiency · fa = Free air · cs = Customer specification · ce = Customer equipment  
Subject to change



### Technical description

<b>General description</b>	* Power consumption when wide open; these values may be considerably higher at the operating point.
<b>Weight</b>	0.620 kg
<b>Dimensions</b>	Ø 150 x 38 mm
<b>Impeller material</b>	Sheet steel, painted black
<b>Housing material</b>	Die-cast aluminum
<b>Airflow direction</b>	Intake over struts
<b>Direction of rotation</b>	Counterclockwise, viewed toward rotor
<b>Storage</b>	Ball bearing
<b>Service life L10 at 40 °C</b>	80000 h
<b>Service life L10 at maximum temperature</b>	37500 h
<b>Cable</b>	Leads AWG 22, TR 64, stripped and tin-plated.
<b>Motor protection</b>	Protection against reverse polarity and blocked rotor.
<b>Locked-rotor protection</b>	Electronic locked-rotor protection
<b>Approval</b>	VDE, CSA, UL, CE
<b>Option</b>	Speed signal



## Product drawing

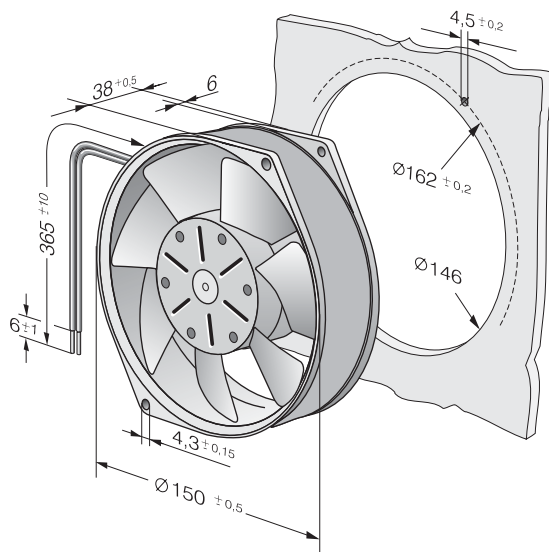

## Curves: Air performance

