

**ebm-papst St. Georgen GmbH & Co. KG**

Hermann-Papst-Str. 1
 D-78112 St. Georgen
 Phone +49 (0) 7724 81-0
 Fax +49 (0) 7724 81-1309
 sales@fansco.com
 www.fansco.com

Nominal data

Type	6318 /2HP	
Nominal voltage	VDC	48
Nominal voltage range	VDC	36 .. 72
Speed (rpm)	min ⁻¹	5000
Power consumption	W	32
Min. ambient temperature	°C	-20
Max. ambient temperature	°C	65
Air flow	m ³ /h	545
Sound power level	B	6.9
Sound pressure level	dB(A)	58

ml = Max. load · me = Max. efficiency · fa = Free air · cs = Customer specification · ce = Customer equipment
 Subject to change



Technical description

General description	Power consumption when wide open; these values may be considerably higher at the operating point.
Impeller material	Glass-fiber reinforced PA plastic
Weight	0.91 kg
Dimensions	Ø 172 x 51 mm
Housing material	Die-cast aluminum
Airflow direction	Exhaust over struts
Direction of rotation	Counterclockwise, viewed toward rotor
Storage	Ball bearing
Service life L10 at 40 °C	77500 h
Service life L10 at maximum temperature	42500 h
Cable	With leads AWG 22, TR 64



Product drawing

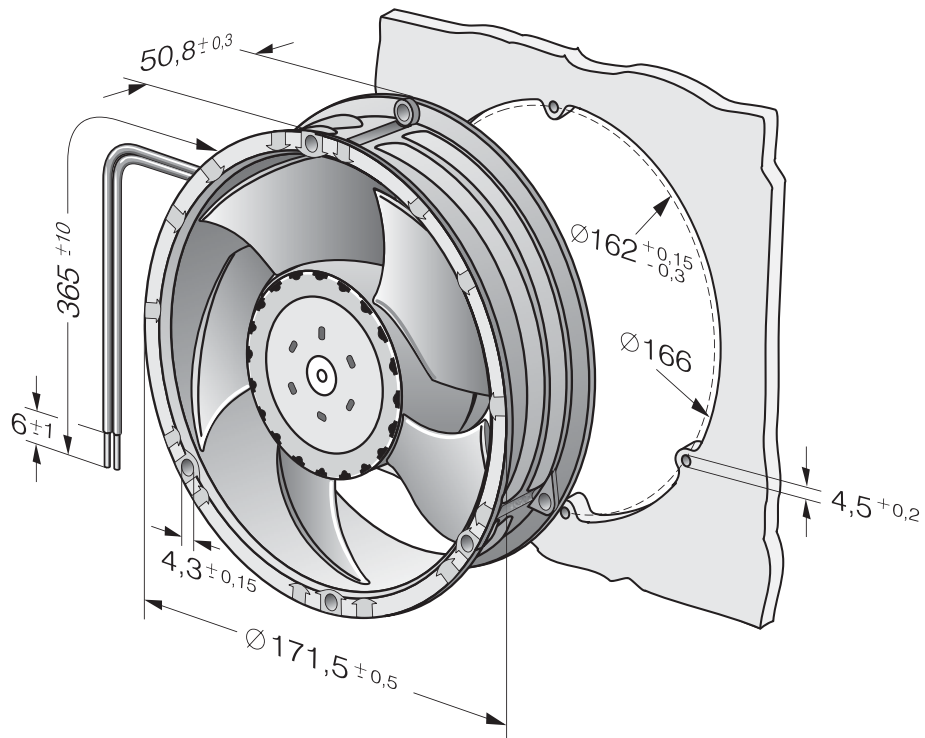

Curves

