

Product Data Sheet 5214 N/2HH

**ebmpapst**

The engineer's choice



5214 N/2HH

INDEX

<b>1</b>	<b>General</b> .....	<b>3</b>
<b>2</b>	<b>Mechanics</b> .....	<b>3</b>
2.1	General.....	3
2.2	Connections.....	3
<b>3</b>	<b>Operating Data</b> .....	<b>4</b>
3.1	Electrical Operating Data .....	4
3.2	Electrical Interface - Output.....	5
3.3	Electrical Features .....	5
3.4	Aerodynamics .....	7
3.5	Sound Data.....	8
<b>4</b>	<b>Environment</b> .....	<b>8</b>
4.1	General.....	8
4.2	Climatic Requirements .....	8
<b>5</b>	<b>Safety</b> .....	<b>9</b>
5.1	Electrical Safety .....	9
5.2	Approval Tests .....	9
<b>6</b>	<b>Reliability</b> .....	<b>9</b>
6.1	General.....	9

## 1 General

Fan type	Fan	
Rotating direction looking at rotor	Counterclockwise	
Airflow direction	Air outlet over struts	
Bearing system	Ball bearing	
Mounting position - shaft	Any	

## 2 Mechanics

### 2.1 General

Width	127,0 mm	
Height	127,0 mm	
Depth	38,0 mm	
Mass	0,315 kg	
Housing material	Plastic	
Impeller material	Plastic	
Max. torque when mounted across both mounting flanges	Wire outlet corner: 10 Ncm Remaining corners: 60 Ncm	
Screw size	ISO 4762 - M4 degreased, without an additional brace and without washer	

### 2.2 Connections

Electrical connection	Wires	
Lead wire length	L = 310 mm	
Tolerance	+ - 10,0 mm	
Wire size (AWG)	22	
Insulation diameter	1,70 mm	

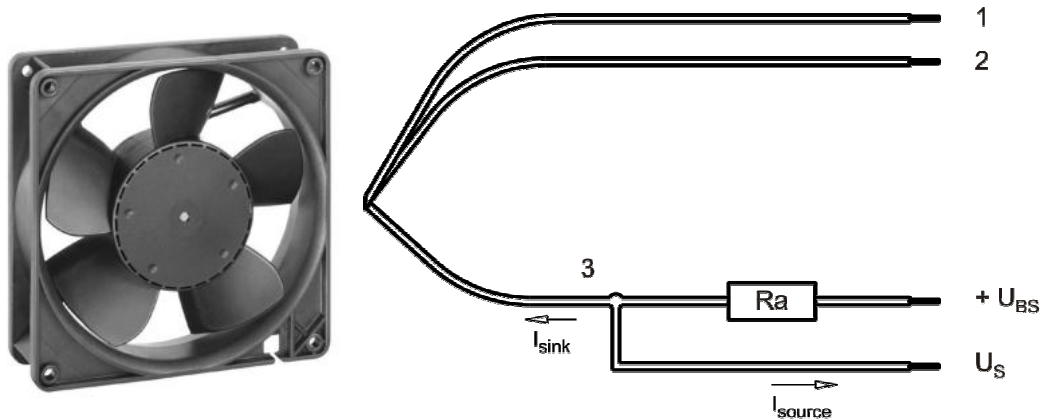

Wire	Color	Operation
1	red	+ UB
2	blue	- GND
3	white	Tacho

The auxiliaries shown on the schematic diagram (which are required for the intended use) are not part of our delivery.

### 3 Operating Data

#### 3.1 Electrical Operating Data

Measurement conditions: Normal air density = 1,2 kg/m<sup>3</sup>; Temperature 23°C +/- 3°C; Motor axis horizontal; warm-up time before measuring 5 minutes (unless otherwise specified). In the intake and outlet area should not be any solid obstruction within 0,5 m.

$\Delta p = 0$ : corresp. to free air flow (see chapter aerodynamics)  
I: corresp. to arithm. mean current value

**Note:**

**No inrush current at Unom means:**

The internal electrolytic capacitor 120uF/50V has no resistor or inrush current limitation, essentially the power supply and the type and length of the connecting cable is limiting the Inrush current.

Features	Condition	Symbol	Values		
Voltage range		U	16 V		30,0 V
Nominal voltage		U <sub>N</sub>		24,0 V	
Power consumption	$\Delta p = 0$	P	9,6 W	17,5 W	19,5 W
Tolerance	0010		+/- 15 %	+/- 15,0 %	+/- 15,0 %
Current consumption	$\Delta p = 0$	I	600 mA	730 mA	650 mA
Tolerance	0010		+/- 15,0 %	+/- 15,0 %	+/- 15,0 %
Speed	$\Delta p = 0$	n	3.800 1/min	4.900 1/min	4.900 1/min
Tolerance	0010		+/- 10,0 %	+/- 10,0 %	+/- 10,0 %
Starting current consumption				3.300 mA	

### 3.2 Electrical Interface - Output

Tacho type	/2 (open collector)
------------	---------------------

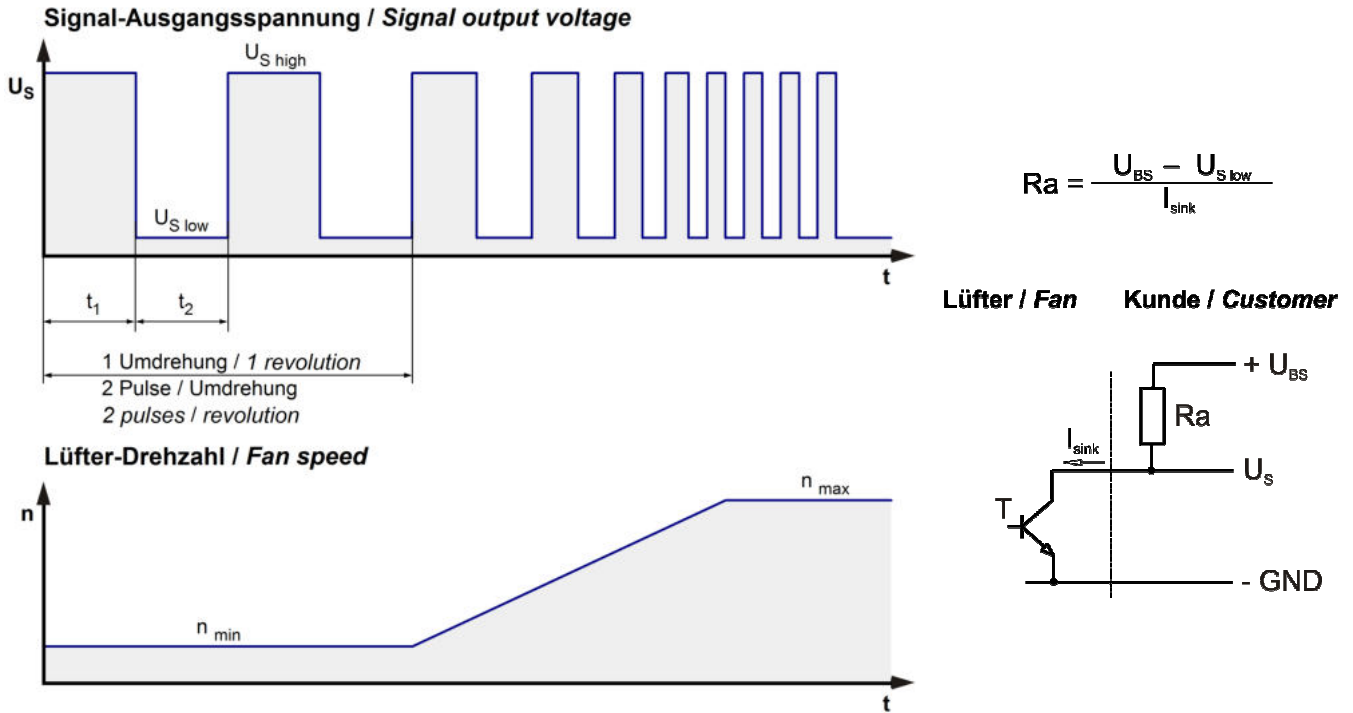

Features	Note	Values
Tacho operating voltage	$U_{BS}$	Min.: 4 V    Max.: 30 V
Tacho signal Low	$U_{S\ low}$	$\leq 0,4\ V$
Tacho signal High	$U_{S\ high}$	30 V
Maximum sink current	$I_{sink}$	$\leq 10\ mA$
External resistor	External resistor $R_a$ from $U_{BS}$ to $U_S$ required. All voltages measured to GND.	
Tacho frequency	$(2 \times n) / 60$	
Tacho isolated from motor	No	
Slew rate		$\Rightarrow 0,5\ V/\mu s$

$n$  = revolutions per minute (1/min)

### 3.3 Electrical Features

Electronic function	Speed-Controlled	
Reversed polarity protection	Rectifying diode	
Max. residual current at $U_N$	$I_F \leq 10\ mA$	
Locked rotor protection	Auto restart	
Locked rotor current at $U_N$	$I_{block}$ approx. 3.300 mA	
Clock signal at locked rotor	$t_3 / t_4$ typical: 1,2 s / 5,0 s	

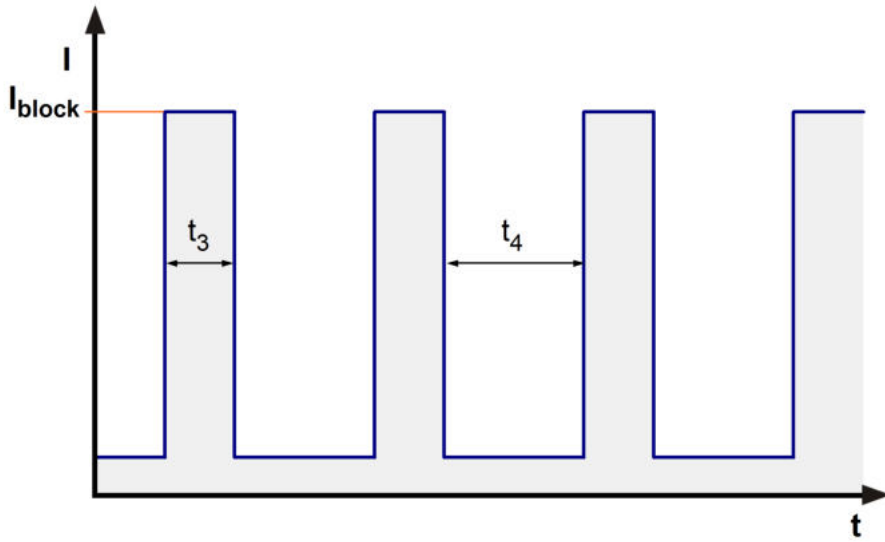

**Internal Fuse:**

Littlefuse NANO2(R) FUSE; Very fast acting 451 Series; 3 A (Art.-Nr.: 451003)

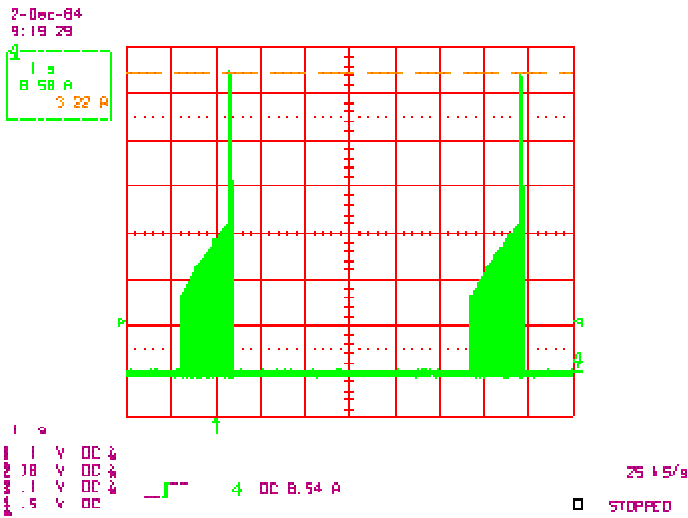

### 3.4 Aerodynamics

Measurement conditions:

Measured with a double chamber intake rig acc. to DIN EN ISO 5801.

Normal air density = 1,2 kg/m<sup>3</sup>; Temperature 23°C +/- 3°C;

In the intake and outlet area should not be any solid obstruction within 0,5 m. Motor shaft horizontal.

The information is only valid under the specified test conditions and may be changed by the installation conditions. If there are deviations from the standard test conditions, the characteristic values must be checked under the installed conditions. Power consumption of the fan motor when operating at normal voltage is shown. Depending on the operating conditions of the application, the power input may be higher.

a.) Operation condition:

4.900 1/min at free air flow

Max. free-air flow ( $\Delta p = 0 / \dot{V} = \text{max.}$ )	340,0 m <sup>3</sup> /h	
Max. static pressure ( $\Delta p = \text{max.} / \dot{V} = 0$ )	215 Pa	

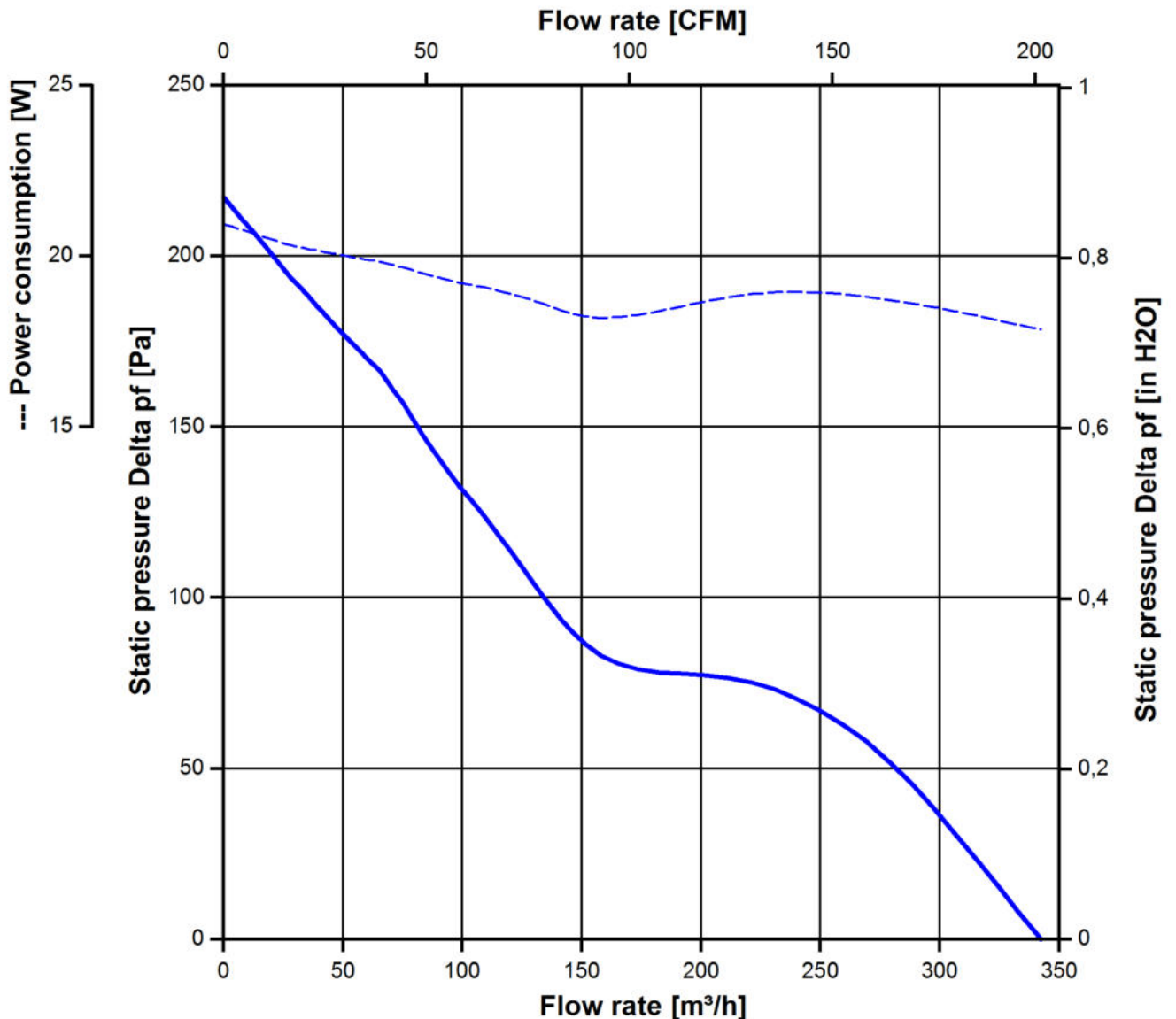

### 3.5 Sound Data

Measurement conditions: Sound pressure level: 1 meter distance between microphone and the air intake.  
 Sound power level: Acc. to DIN 45635 part 38 (ISO 10302)  
 Measured in a semianchoic chamber with a background noise level of  $L_p(A) < 5 \text{ dB(A)}$   
 For further measurement conditions see chapter aerodynamics.

a.) Operation condition:

4.900 1/min at free air flow		
Optimal operating point	210 m <sup>3</sup> /h @ 76 Pa	
Sound power level at the optimal operating point	6,6 bel(A)	
Sound pressure level at free air flow, measured in rubber bands	58,0 dB(A)	

## 4 Environment

### 4.1 General

Min. permitted ambient temperature TU min.	-20 °C	
Max. permitted ambient temperature TU max.	65 °C	
Min. permitted storage temperature TL min.	-40 °C	
Max. permitted storage temperature TL max.	80 °C	

### 4.2 Climatic Requirements

Humidity requirements	humid heat, constant; according to DIN EN 60068-2-78, 14 days	
Water exposure	None	
Dust requirements	None	
Salt fog requirements	None	

Permitted application area:

The product is intended for use in sheltered rooms with controlled temperature and controlled humidity. Directly exposure to water must be avoided.

Pollution degree 1 (according DIN EN 60664-1)

There is either no pollution or it occurs only dry, non-conductive pollution. The pollution has no negative impact.

Please require severity levels and specification parameters from the responsible development departments.



**5 Safety**

**5.1 Electrical Safety**

Dielectric strength DIN EN 60950 (VDE 0805) and DIN EN 60335 (VDE 0700) A.) Type test Measuring conditions: After 48h of storage at 95% R.H. and 25°C. No arcing or breakdown is allowed! All connections together to ground.	500 VAC / 1 Min.	
B.) Routine test Measuring conditions: At indoor climate. No arcing or breakdown is allowed! All connections together to ground.	850 VDC / 1 Sec.	
Isolation resistance Measuring conditions: After 48h of storage at 95% R.H. and 25°C measured with U=500 VDC for 1 min.	RI > 10 MOhm	
Clearance / creepage distance	1,0 mm / 1,2 mm	
Protection class	III	

**5.2 Approval Tests**

CE	EC Declaration of Conformity	Yes
EAC	Eurasian Conformity	Yes
UL	Underwriters Laboratories	Yes / UL507, Electric Fans
VDE	Association for Electrical, Electronic and Information Technologies	Yes / Approval acc. to EN 60950 (VDE 0805) - Information technology equipment
CSA	Canadian Standards Association	Yes / C22.2 No. 113 Fans and Ventilators
CCC	China Compulsory Certification	Not applicable

The approval tests are observed to:

U approval max.:30,0 V @ TU approval max.: 65,0 °C

**6 Reliability**

**6.1 General**

Life expectancy L10 at TU = 40 °C	45.000 h	
Life expectancy L10 at TU max.	25.000 h	
Life expectancy L10 acc. to IPC 9591 at TU = 40 °C	75.0 00 h	

Notes of the recipient are compulsory if they are not to be used for construction. The contents, brand and  
 number of the recipient are compulsory. The recipient is liable for the correct use of the recipient. The recipient  
 is not liable for the correct use of the recipient. The recipient is liable for the correct use of the recipient.

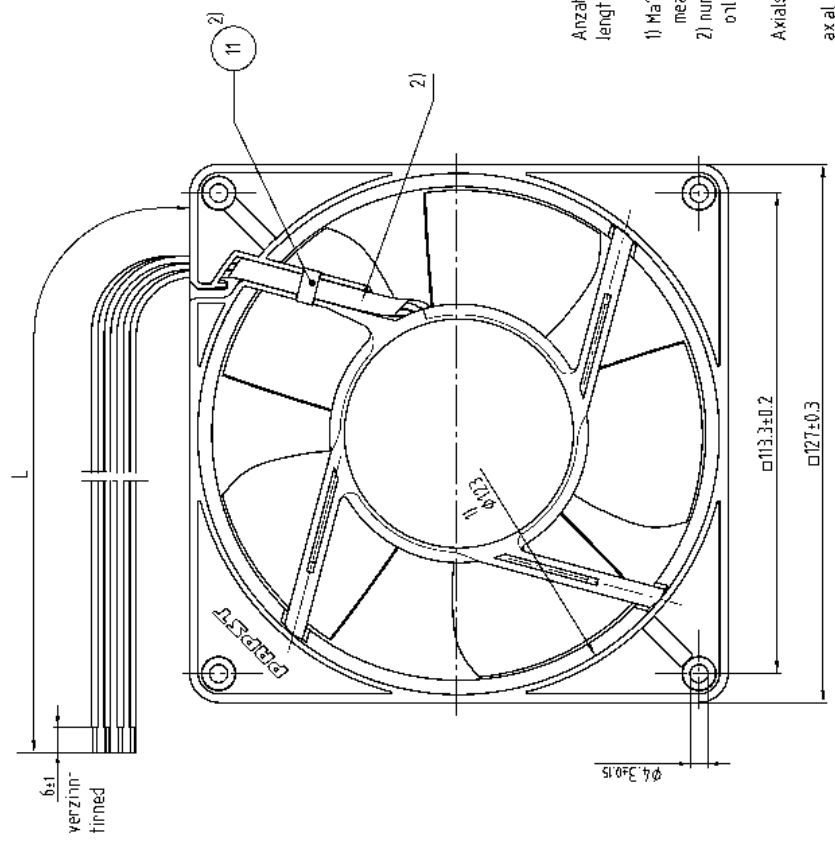

Anzahl und Länge der Litzen siehe BV-Blatt 1  
 length and number of wires see design specifications page 1

1) Maße für Montagewand  
 measures for mounting plate  
 2) nur, wenn in Stückliste angegeben  
 only, if included in bill of material

Axialspiel bei Kugellagerung mit Feder frei ver-spannt  
 bei Gleitlagerung 0,1 - 0,6 mm  
 axial tolerance of ball bearing without axial clearance by a preloaded spring  
 by sleeve bearing 0,1 - 0,6 mm

Technische Zeichnung: DIN 7167 Zeichnungsart: Längsschnitt Blatt: 1 von 1 Blattgröße: DIN A3		Norm: DIN ISO 2168-nK 		Material: L11E
Bauteilname: Ventilator	Bauteilnummer: 113.3	Zeichnung: 113.3	Blattgröße: A3	Blattzahl: 1
Hersteller: ebmpapst				
Zeichnung: 113.3				
Blattgröße: A3				