

**ebm-papst St. Georgen GmbH & Co. KG**

Hermann-Papst-Str. 1

D-78112 St. Georgen

Phone +49 (0) 7724 81-0

Fax +49 (0) 7724 81-1309

sales@fansco.com

www.fansco.com

Nominal data

Type	4412 M	
Nominal voltage	VDC	12
Nominal voltage range	VDC	7 .. 14
Speed (rpm)	min ⁻¹	3300
Power consumption	W	3.8
Min. ambient temperature	°C	-20
Max. ambient temperature	°C	75
Air flow	m ³ /h	184
Sound power level	B	5.3
Sound pressure level	dB(A)	42

ml = Max. load · me = Max. efficiency · fa = Free air · cs = Customer specification · ce = Customer equipment
Subject to change



Technical description

Housing material	Glass-fiber reinforced PBT plastic
Impeller material	Glass-fiber reinforced PA plastic
Weight	0.250 kg
Dimensions	119 x 119 x 38 mm
Airflow direction	Exhaust over struts
Direction of rotation	Clockwise, viewed toward rotor
Storage	Ball bearing
Service life L10 at 40 °C	65000 h
Service life L10 at maximum temperature	25000 h
Cable	Leads AWG 24, TR 64, stripped and tin-plated.
Motor protection	Protection against reverse polarity and blocked rotor.
Option	Control inputs and alarm and speed signals.



Product drawing

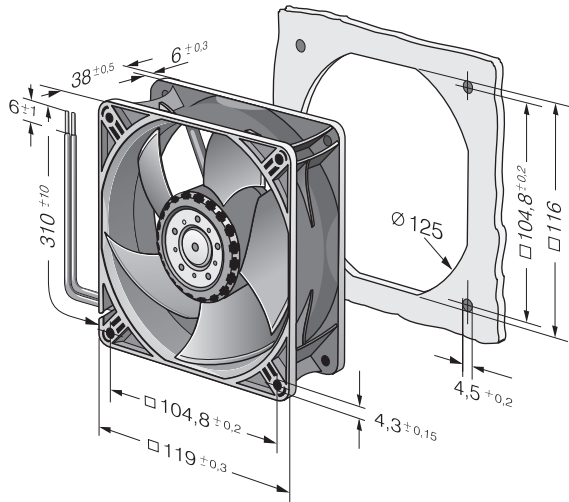

Curves: Air performance

