

4312 L

DC axial compact fan



ebm-papst St. Georgen GmbH & Co. KG

Hermann-Papst-Str. 1
D-78112 St. Georgen
Phone +49 (0) 7724 81-0
Fax +49 (0) 7724 81-1309
sales@fansco.com
www.fansco.com

Nominal data

Type	4312 L	
Nominal voltage	VDC	12
Nominal voltage range	VDC	6 .. 15
Speed (rpm)	min ⁻¹	1550
Power consumption	W	1.2
Min. ambient temperature	°C	-20
Max. ambient temperature	°C	75
Air flow	m ³ /h	95
Sound power level	B	4.3
Sound pressure level	dB(A)	30

ml = Max. load · me = Max. efficiency · fa = Free air · cs = Customer specification · ce = Customer equipment
Subject to change



Technical description

Housing material	Glass-fiber reinforced PBT plastic
Impeller material	Glass-fiber reinforced PA plastic
Weight	0.220 kg
Dimensions	119 x 119 x 32 mm
Airflow direction	Exhaust over struts
Direction of rotation	Clockwise, viewed toward rotor
Storage	Ball bearing
Service life L10 at 40 °C	80000 h
Service life L10 at maximum temperature	35000 h
Cable	Leads AWG 22, TR 64, stripped and tin-plated.
Motor protection	Protection against reverse polarity and blocked rotor.
Locked-rotor protection	Locked-rotor and overload protection
Approval	VDE, CSA, UL, CE
Option	Vario-Pro



Product drawing

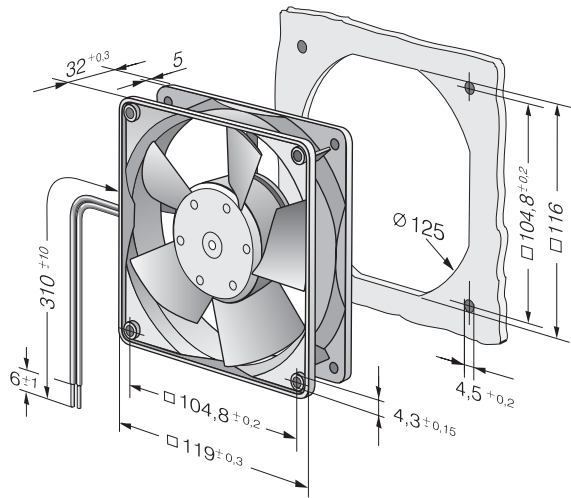

Curves: Air performance

