

**ebm-papst St. Georgen GmbH & Co. KG**

Hermann-Papst-Str. 1

D-78112 St. Georgen

Phone +49 (0) 7724 81-0

Fax +49 (0) 7724 81-1309

sales@fansco.com

www.fansco.com

Nominal data

Type	3506	
Phase		1~
Nominal voltage	VAC	115
Frequency	Hz	60
Speed (rpm)	min ⁻¹	2600
Power consumption	W	8.0
Min. ambient temperature	°C	-40
Max. ambient temperature	°C	95
Air flow	m ³ /h	73
Sound power level	B	4.7
Sound pressure level	dB(A)	36

ml = Max. load · me = Max. efficiency · fa = Free air · cs = Customer specification · ce = Customer equipment
Subject to change



Technical description

Weight	0.420 kg
Dimensions	92 x 92 x 38 mm
Impeller material	Sheet steel, painted black
Housing material	Die-cast aluminum
Part no.	9244014730
Airflow direction	Exhaust over struts
Direction of rotation	Clockwise, viewed toward rotor
Bearing	Ball bearing
Service life L10 at 40 °C	62500 h
Service life L10 at maximum temperature	17500 h
Cable	With 2 leads AWG 18 Grounding lug M4 x 8
Motor protection	Protected from overload by impedance protection
Approval	VDE, CSA, UL, CE



Product drawing

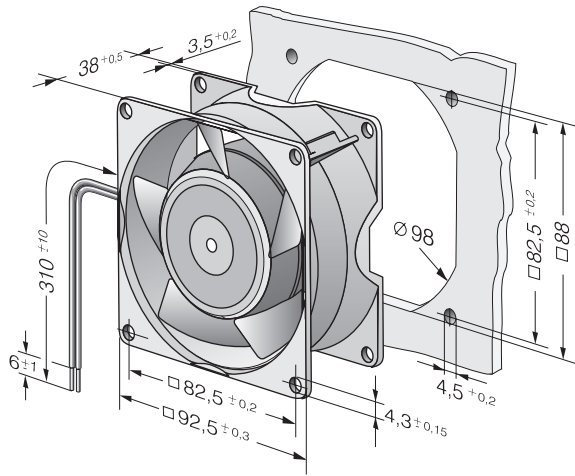

Curves: Air performance

