

**ebm-papst St. Georgen GmbH & Co. KG**

Hermann-Papst-Str. 1
 D-78112 St. Georgen
 Phone +49 (0) 7724 81-0
 Fax +49 (0) 7724 81-1309
 sales@fansco.com
 www.fansco.com

Nominal data

Type	3218 JH3	
Nominal voltage	VDC	48
Nominal voltage range	VDC	20 .. 58
Speed (rpm)	min ⁻¹	11000
Power consumption	W	29
Min. ambient temperature	°C	-20
Max. ambient temperature	°C	70
Air flow	m ³ /h	237
Sound power level	B	7.8
Sound pressure level	dB(A)	69

ml = Max. load · me = Max. efficiency · fa = Free air · cs = Customer specification · ce = Customer equipment
 Subject to change



Technical description

General description	* Power consumption when wide open; these values may be considerably higher at the operating point.
Housing material	Glass-fiber reinforced PBT plastic
Impeller material	Glass-fiber reinforced PA plastic
Weight	0.280 kg
Dimensions	92 x 92 x 38 mm
Airflow direction	Exhaust over struts
Direction of rotation	Clockwise, viewed toward rotor
Storage	Ball bearing
Service life L10 at 40 °C	65000 h
Service life L10 at maximum temperature	32500 h
Cable	Leads AWG 22, TR 64, stripped and tin-plated.
Motor protection	Protection against reverse polarity and blocked rotor.
Approval	VDE, CSA, UL
Option	Speed signal



Product drawing

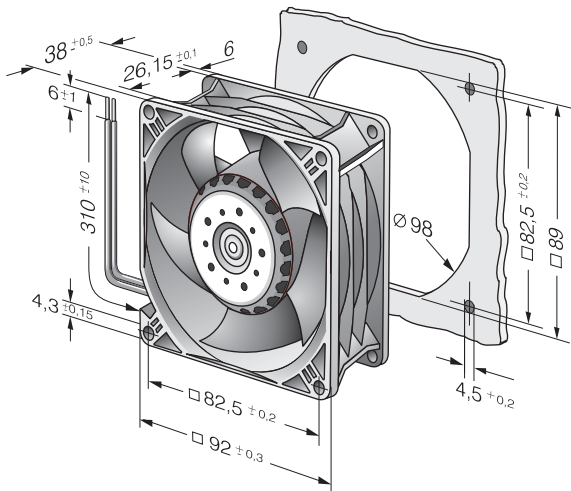

Curves: Air performance

