



The engineer's choice

ebmpapst

3214 J/2H3F-191

INDEX

1 General 3

2 Mechanics 3

 2.1 General 3

 2.2 Connections 3

3 Operating Data 4

 3.1 Operating Data - Electrical Interface - Input 4

 3.2 Electrical Operating Data 5

 3.3 Operating Data - Electrical Interface -Output 6

 3.4 Electrical Features 7

 3.5 Aerodynamic 8

 3.6 Sound Data 9

4 Environment 9

 4.1 General 9

 4.2 Climatic requirements*) 9

5 Safety 10

 5.1 Electrical Safety 10

 5.2 Approval Tests 10

6 Reliability 10

 6.1 General 10

1 General

Fan type	Fan	
Rotational direction looking at rotor	clockwise	
Airflow direction	Air outlet over struts	
Bearing system	Ball bearing	
Mounting position	any	

2 Mechanics

2.1 General

Width	92,0 mm	
Height	92,0 mm	
Depth	38,0 mm	
Weight	0,240 kg	
Housing material	Plastic	
Impeller material	Plastic	
Max. torque when mounted across both mounting flanges	wire outlet corner: 30 Ncm remaining corners: 30 Ncm	
Screw size	ISO 4762 - M4 degreased, without an additional brace and without washer	

2.2 Connections

Electrical connection	Wires	
Length of lead wire	310 mm	
Tolerance	+/- 10,0 mm	
Wire gauge (AWG)	24	
Insulation diameter	1,55 mm	
Contact	see drawing	

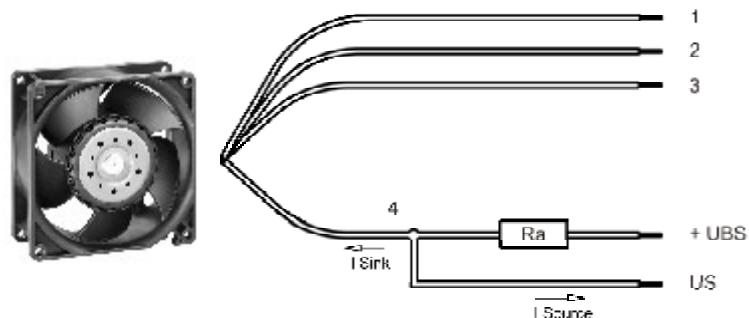

	Colour	Operation
Wire 1	red	+ UB
Wire 2	blue	- GND
Wire 3	violet	FREQ
Wire 4	white	Tacho

The auxiliaries shown on the schematic diagram (which are required for the intended use) are not part of our delivery.

3 Operating Data

3.1 Operating Data - Electrical Interface - Input

Control input	Frequency
---------------	-----------

Features

Input type	TTL	
Input frequency range		116 Hz - 350 Hz

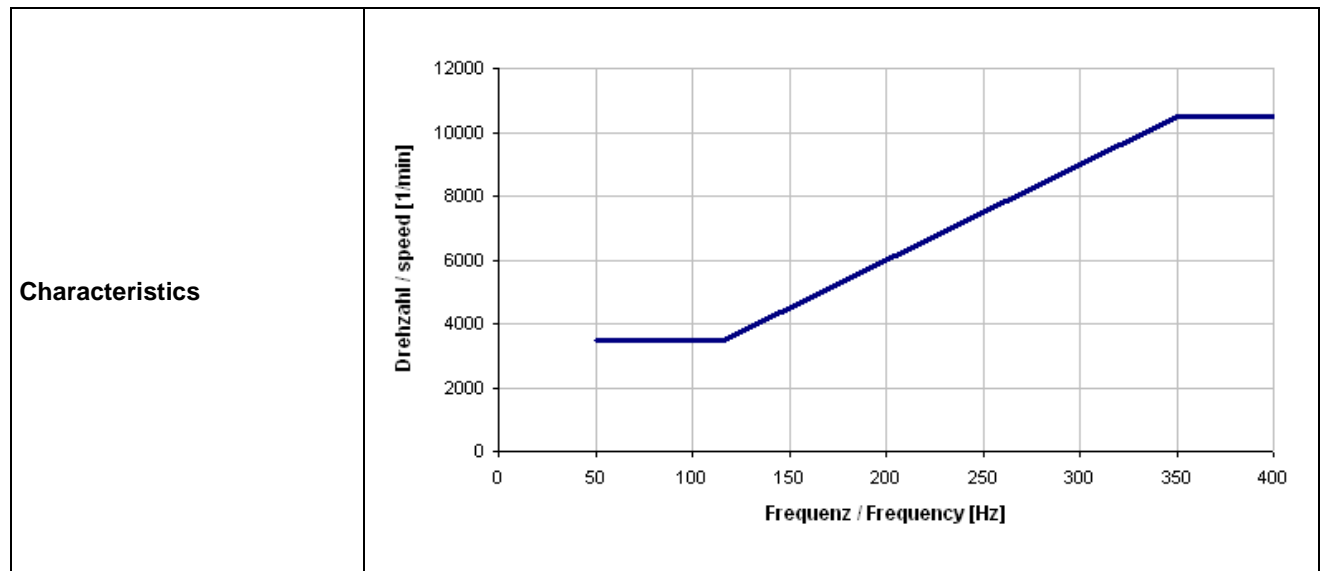

Attention: Important information to the speed control!

116... 350 Hz; TTL Logik; 3.500... 10.500 1/min
 0 Hz... 50 Hz -> not permitted, because:
 0 Hz (high level), 0 1/min and
 0 Hz (low level), 10.500 1/min

3.2 Electrical Operating Data

Measurement conditions: Normal air density = 1,2 kg/m³; Temperature 23°C +/- 3°C; Motor axis horizontal; warm-up time before measuring 5 minutes (unless otherwise specified). In the intake and outlet area should not be any solid obstruction within 0,5 m.

$\Delta p = 0$: corresp. to free air flow (see section 3.5)
 I: corresp. to arithm. mean current value

Name	Condition
Frequency 0001	Frequency: 350 Hz

Features	Condition	Symbol	Values		
Voltage range	$\Delta p = 0$	U	20,0 V		26,0 V
Nominal voltage	$\Delta p = 0$	U_N		24,0 V	
Power consumption	$\Delta p = 0$	P	20,0 W	28,3 W	31,2 W
Tolerance	Frequency 0001		+/- 18,0 %	+/- 25,0 %	+/- 25,0 %
Current consumption	$\Delta p = 0$	I	1.000 mA	1.180 mA	1.200 mA
Tolerance	Frequency 0001		+/- 18,0 %	+/- 25,0 %	+/- 25,0 %
Speed	$\Delta p = 0$	n	9.250 1/min	10.500 1/min	10.500 1/min
Tolerance	Frequency 0001		+/- 13,0 %	+/- 3,0 %	+/- 3,0 %
Starting current consumption				<= 5.000 mA	

Name	Condition
Frequency 0002	Frequency: 116 Hz

Features	Condition	Symbol	Values		
Voltage range	$\Delta p = 0$	U	20,0 V		26,0 V
Nominal voltage	$\Delta p = 0$	U_N		24,0 V	
Power consumption	$\Delta p = 0$	P	3,4 W	3,8 W	4,2 W
Tolerance	Frequency 0002		+/- 25,0 %	+/- 25,0 %	+/- 25,0 %
Current consumption	$\Delta p = 0$	I	170 mA	160 mA	160 mA
Tolerance	Frequency 0002		+/- 25,0 %	+/- 25,0 %	+/- 25,0 %
Speed	$\Delta p = 0$	n	3.500 1/min	3.500 1/min	3.500 1/min
Tolerance	Frequency 0002		+/- 3,0 %	+/- 3,0 %	+/- 3,0 %

3.3 Operating Data - Electrical Interface -Output

Tacho type	/2 (Open collector)
------------	---------------------

Signal-Ausgangsspannung / *Signal output voltage*

$$R_a = \frac{U_{BS} - U_{S\ Low}}{I_{Sink}}$$

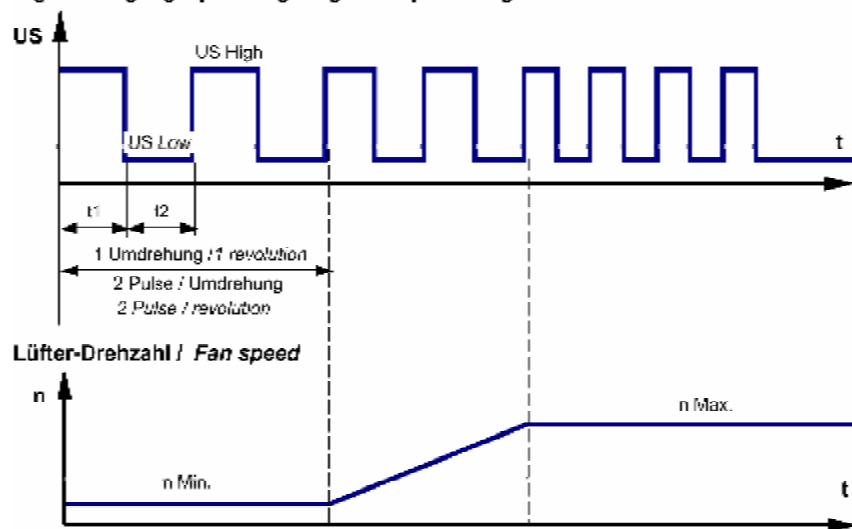

Features	Note	Values
Tacho operating voltage (UBS)		<= 60,0 V
Tacho signal Low	I sink: 2 mA	<= 0,4 V
Tacho signal High	I source: 0 mA	60 V
Maximum sink current		<= 4 mA
External resistor	External resistor Ra from UBS to US required. All voltages measured to GND.	
Tacho frequency	(2 x n) / 60	
Tacho isolated from motor	No	
Slew rate		=> 0,5 V/us

Alarm type	None
------------	------

3.4 Electrical Features

Electronic function	Speed-Controlled	
Reversed polarity protection	None	
Max. residual current at U_n		
Locked rotor protection	Auto restart	
Locked rotor current at U_n	approx. 3.500 mA	
Clock signal t_3/t_4 at locked rotor	Typical: 0,3 s / 10,0 s	

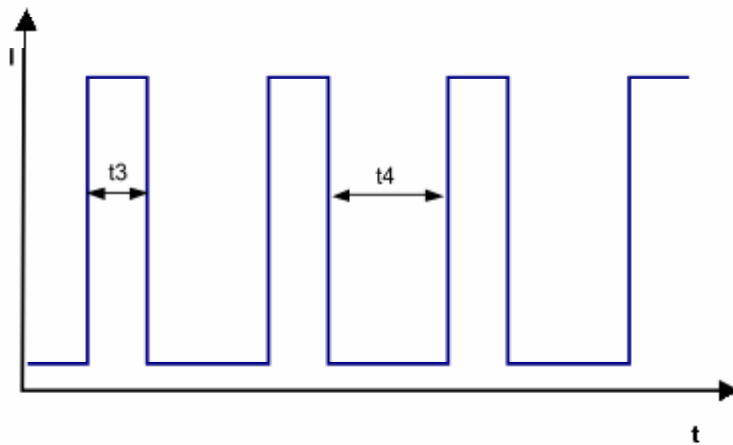

3.5 Aerodynamic

Measurement conditions: Measured with a double chamber intake rig acc. to DIN EN ISO 5801.
 Normal air density = 1,2 kg/m³; Temperature 23°C +/- 3°C;
 In the intake and outlet area should not be any solid obstruction within 0,5 m.

a.) Operation condition:

10.500 1/min at free air flow	Frequency: 350Hz		
-------------------------------	------------------	--	--

Max. free-air flow ($\Delta p = 0 / \dot{V} = \text{max.}$)	230,0 m ³ /h	
Max. static pressure ($\Delta p = \text{max.} / \dot{V} = 0$)	615 Pa	

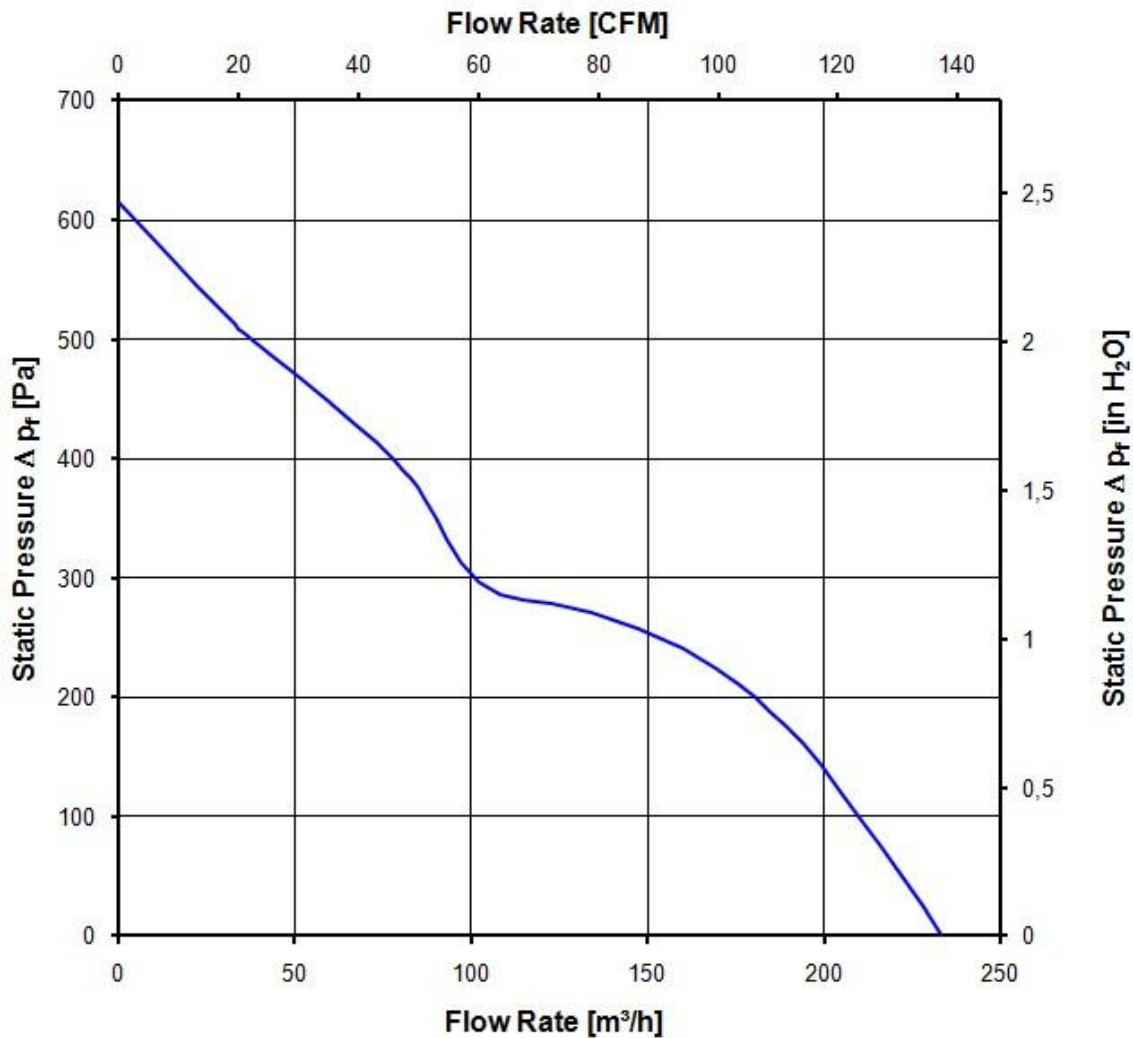

3.6 Sound Data

Measurement conditions: Sound pressure level: 1 Meter distance between microphone and the air intake.
 Sound power level: Acc. to DIN 45635 part 38 (ISO 10302)
 Measured in a semianchoic chamber with a background noise level of $L_p(A) < 5 \text{ dB(A)}$
 For further measurement conditions see section 3.5

a.) Operation condition:

10.500 1/min at free air flow	Frequency: 350Hz		
Optimal operating point	150,0 m3/h @ 224 Pa		
Sound power level at the optimal operating point	7,5 bel(A)		
Sound pressure level at free air flow, measured in rubber bands	66,0 dB(A)		

4 Environment

4.1 General

Min. permitted ambient temperature TU min.	-20 °C	
Max. permitted ambient temperature TU max.	55 °C	
Min. permitted storage temperature TL min.	-40 °C	
Max. permitted storage temperature TL max.	80 °C	

4.2 Climatic requirements *)

Humidity requirements	humid heat, constant; according to DIN EN 60068-2-78, 14 days	
Water exposure	None	
Radiation exposure	None	
Dust requirements	None	
Salt fog requirements	None	
Harmful gas requirements	None	

*) Permitted application area:

The product is intended for use in sheltered rooms with controlled temperature and controlled humidity. Directly exposure to water must be avoided.

Pollution degree 1 (according DIN EN 60664-1)

There is either no pollution or it occurs only dry, non-conductive pollution. The pollution has no negative impact. Please require severity levels and specification parameters from the responsible development departments

5 Safety

5.1 Electrical Safety

Dielectric strength DIN EN 60950 (VDE 0805) and DIN EN 60335 (VDE 0700) A.) Type test Measuring conditions: After 48h of storage at 95% R.H. and 25°C. No arcing or breakdown is allowed! All connections together to ground.	500 VAC / 1 Min.	
B.) Routine test Measuring conditions: At indoor climate. No arcing or breakdown is allowed! All connections together to ground.	500 VAC / 1 Sec.	
Isolation resistance Measuring conditions: After 48h of storage at 95% R.H. and 25°C measured with U=500 VDC for 1 min.	RI > 10 MOhm	
Air and leakage distances	1,0 mm / 1,2 mm	
Protection class	III	

5.2 Approval Tests

CE	Yes
UL	Yes / UL507, Electric Fans
VDE	No
CSA	Yes / CSA audited by UL according to C22.2 No. 113 Fans and Ventilators
CCC	No

The approval tests are observed to:

Maximal permitted operating voltage (see section 3.1) and max. permitted ambient temperature TU max.

6 Reliability

6.1 General

Life expectancy L10 at TU = 40 °C	45.000 h	
Life expectancy L10 at TU max.	30.000 h	

Copying of this document and giving it to others and the use or communication of its contents, however, and
 the use of the information contained herein for other purposes, are prohibited. Rights are reserved
 in full for the year of publication or the registration of a utility model or design.

Spindelvermerk nach DIN ISO 1000 beachten

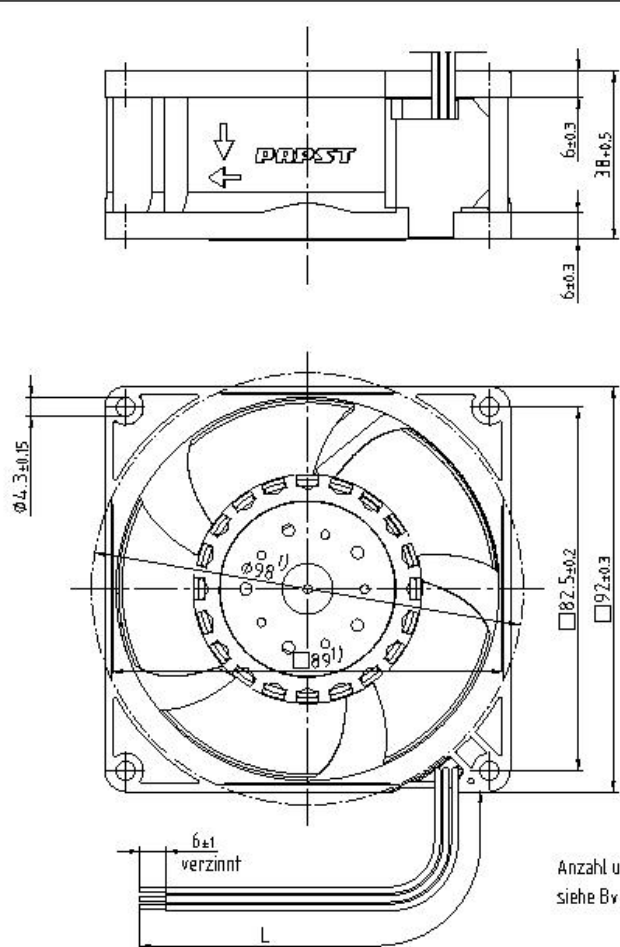

Anzahl und Länge der Litzen
siehe Bv - Bl.1

Axialspiel bei
 - Kugellagerung (K): 0 (mit Federausgleich)
 - Gleitlagerung (G): 0.1 - 1.6

1) Maße für Montagewand

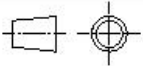
Tolerierung: DIN 7167		Artikel		Maßstab
Allgemeintoleranzen: DIN ISO 2768-mK-E				
	Datum	Name		Zchg.-Nr.
Bearbeitet				
	Index	Änd.-Nr.	PAPST PAPST-MOTOREN GmbH & Co KG D-78112 St. Georgen Germany	Blatt
Geprüft u. zur Verwendung freigegeben von		an		
				A4