



SPECIFICATION FOR APPROVAL

Customer : STD

Description : DC FAN

Customer Part No. _____

REV. : _____

Delta Model No. : GFC0948SS-00F4N

REV. : 03

Sample Issue No. : _____

Sample Issue Date : MAY.15 2020

PLEASE SEND ONE COPY OF THIS SPECIFICATION BACK AFTER YOU SIGNED APPROVAL FOR PRODUCTION PRE-ARRANGMENT.

APPROVED BY:

DELTA ELECTRONICS, INC.
TAOYUAN PLANT
252, SHANG YING ROAD, GUISHAN INDUSTRIAL ZONE
TAOYUAN CITY 33341, TAIWAN
TEL:886-(0)3-3591968
FAX:886-(0)3-3591991

DELTA ELECTRONICS, INC.
252, SHANGYING ROAD, GUISHAN INDUSTRIAL ZONE,
TAOYUAN CITY 33341, TAIWAN

TEL : 886-(0)3-3591968
FAX : 886-(0)3-3591991

STATEMENT OF DEVIATION

NONE

DESCRIPTION:

DELTA ELECTRONICS, INC.
252, SHANG YING ROAD, GUISHAN INDUSTRIAL ZONE
TAOYUAN CITY 33341, TAIWAN

TEL : 886-(0)3-3591968
FAX : 886-(0)3-3591991

Specification For Approval

Customer : STD

Description : DC FAN

Customer P/N :

rev. :

Delta model no. : GFC0948SS-00F4N

Delta Safety Model No.: GFC0948SS-00

Sample revision. : 03

Issue no.:

Sample issue date : MAY.15 2020

Quantity :

1. SCOPE:

THIS SPECIFICATION DEFINES THE ELECTRICAL AND MECHANICAL CHARACTERISTICS OF THE DC BRUSHLESS AXIAL FLOW FAN.

2. CHARACTERS:

ITEM	DESCRIPTION
RATED VOLTAGE	48V
OPERATION VOLTAGE	36 - 60 VDC
INPUT CURRENT OF FREE AIR(AVG)	1.00A (MAX. 1.20A) CURRENT ON LABEL : 2.50A
INPUT POWER (AVG.)	48.00 (MAX. 57.60) W
SPEED	FRONT FAN: 11000+/-10% R.P.M. REAR FAN: 11200+/-10% R.P.M.
MAX. AIR FLOW (AT ZERO STATIC PRESSURE)	4.400 (MIN. 3.960) M ³ /MIN. 155.383 (MIN. 139.844) CFM
MAX. AIR PRESSURE (AT ZERO AIRFLOW)	124.97 (MIN. 101.22) mmH2O 4.920 (MIN. 3.985) inchH2O
ACOUSTICAL NOISE (AVG.)	78.5 (MAX.82.5) dB-A
INSULATION TYPE	UL: CLASS A
INSULATION STRENGTH	10 MEG OHM MIN. AT 500 VDC (BETWEEN FRAME AND (+) TERMINAL)
DIELECTRIC STRENGTH	5 mA MAX. AT 500 VAC 50/60 Hz ONE MINUTE, (BETWEEN FRAME AND (+) TERMINAL)

(continued)

PAGE 1

PART NO:

DELTA MODEL: GFC0948SS-00F4N

LIFE EXPECTANCE(IL10) (AT LABEL VOLTAGE)	70,000 HOURS CONTINUOUS OPERATION AT 40 ° C WITH 15 ~ 65 %RH.
ROTATION	TWO FANS ROTATE IN COUNTER DIRECTIONS SHOWN IN THE NAME PLATE SIDE
LOCK ROTOR SHUT DOWN	THE CURRENT WILL SHUT DOWN, WHEN ROTOR LOCKED AND FIXED.

NOTES:

1. ALL READINGS ARE MEASURED AFTER STABLY WARMING UP THROUGH 10 MINUTES.
2. STANDARD AIR PROPERTY IS AIR AT (Td) 25°C TEMPERATURE, (RH) 65% RELATIVE HUMIDITY , AND (Pb) 760 mmHg BAROMETRIC PRESSURE.
3. THE VALUES WRITTEN IN PARENS , (), ARE LIMITED SPEC.
4. ACOUSTICAL NOISE MEASURING CONDITION:

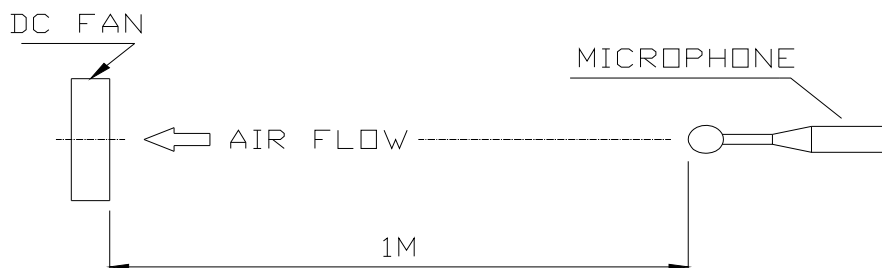

NOISE IS MEASURED AT RATED VOLTAGE IN FREE AIR IN SEMI-ANECHOIC CHAMBER WITH MICROPHONE AT A DISTANCE OF ONE METER FROM THE FAN INTAKE.

PART NO:

DELTA MODEL: GFC0948SS-00F4N

3. MECHANICAL:

- 3-1. DIMENSIONS----- SEE DIMENSIONS DRAWING
- 3-2. FRAME----- PLASTIC UL: 94V-0
- 3-3. IMPELLER----- PLASTIC UL: 94V-0
- 3-4. BEARING SYSTEM----- TWO BALL BEARINGS
- 3-5. WEIGHT----- 390 GRAMS (REF.)

4. ENVIRONMENTAL:

- 4-1. OPERATING TEMPERATURE----- -10 TO +60 DEGREE C
- 4-2. STORAGE TEMPERATURE----- -40 TO +75 DEGREE C
- 4-3. OPERATING HUMIDITY----- 5 TO 90 % RH
- 4-4. STORAGE HUMIDITY----- 5 TO 95 % RH

5. PROTECTION:

- 5-1. LOCKED ROTOR PROTECTION
IMPEDANCE OF MOTOR WINDING PROTECTS MOTOR FROM FIRE IN
96 HOURS OF LOCKED ROTOR CONDITION AT THE RATED VOLTAGE.
- 5-2. POLARITY PROTECTION
BE CAPABLE OF WITHSTANDING IF REVERSE CONNECTION FOR
POSITIVE AND NEGATIVE LEADS.
- 5-3. INTERNAL FUSE IMPLEMENTED.

6. RE OZONE DEPLETING SUBSTANCES:

- 6-1. NO CONTAINING PBBs, PBBOs, CFCs, PBBEs, PBDPEs AND HCFCs.

7. PRODUCTION LOCATION

- 7-1. PRODUCTS WILL BE PRODUCED IN CHINA OR THAILAND.

PART NO:

DELTA MODEL: GFC0948SS-00F4N

8. P & Q CURVE:

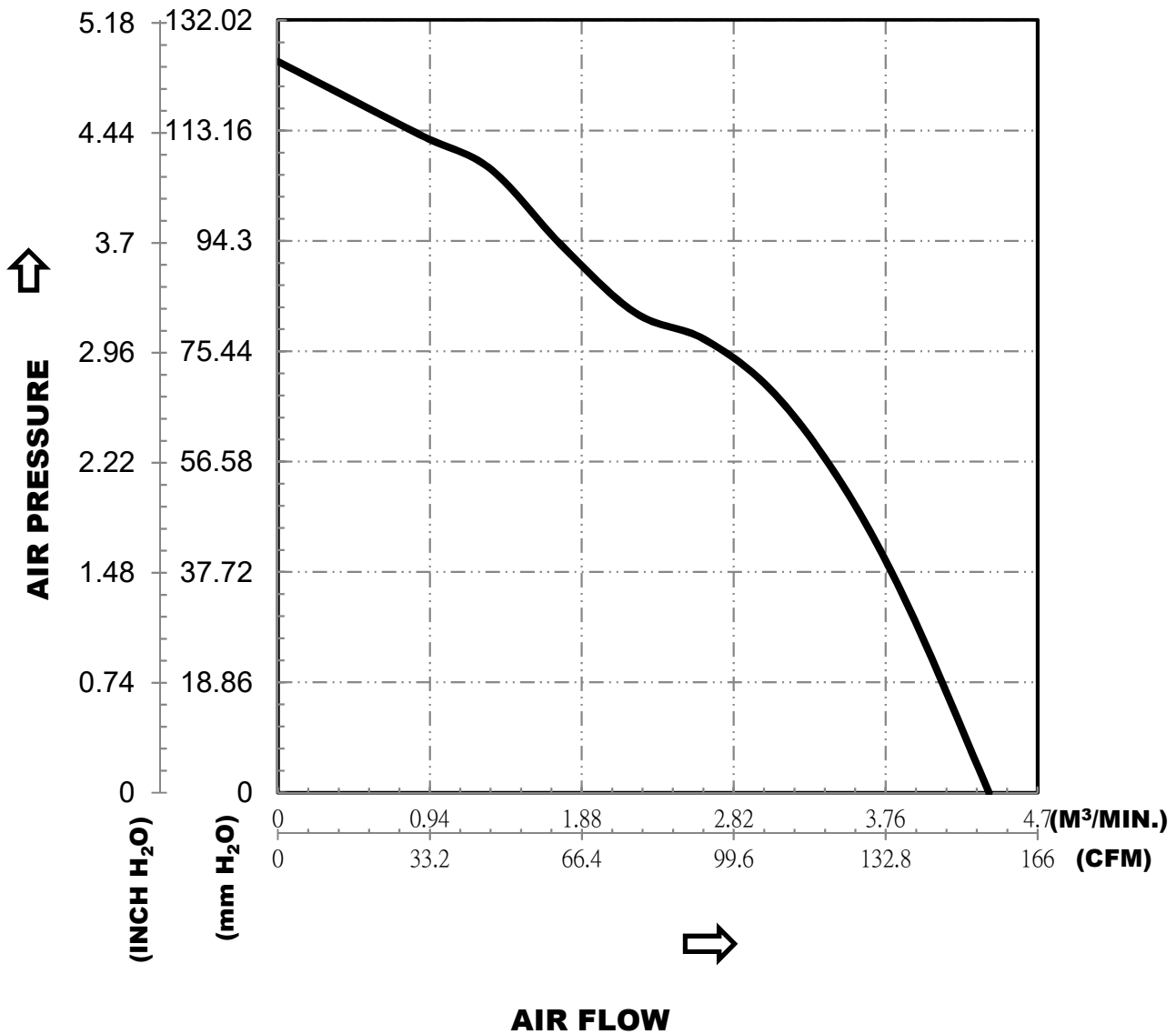

*TEST CONDITION: INPUT VOLTAGE-----OPERATION VOLTAGE
TEMPERATURE-----ROOM TEMPERATURE
HUMIDITY-----65%RH

PART NO:

DELTA MODEL: GFC0948SS-00F4N

9. DIMENSION DRAWING:

LABEL:

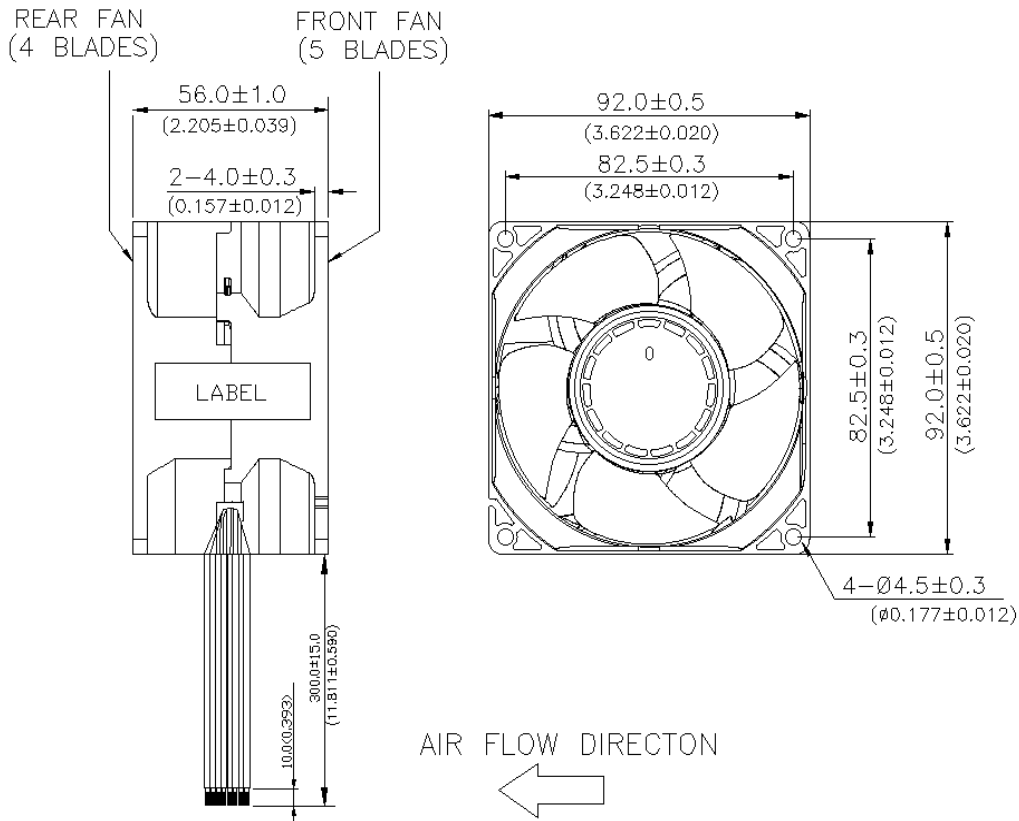
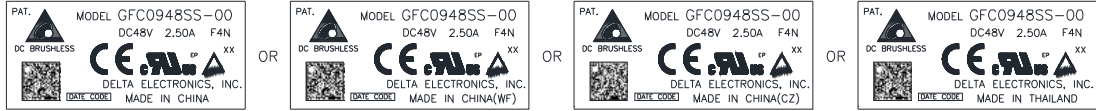

UNIT : MM (INCH)

NOTES:

- LEAD WIRE: UL10368 -F- AWG #24 & AWG #26
 - UL10368 AWG24, BLACK WIRE, FRONT FAN ----- (-)
 - UL10368 AWG24, RED WIRE, FRONT FAN ----- (+)
 - UL10368 AWG26, BLUE WIRE, FRONT FAN ----- (PWM)
 - UL10368 AWG26, WHITE WIRE, REAR FAN ----- (PWM)
 - UL10368 AWG26, YELLOW WIRE, FRONT FAN ----- (F00)
 - UL10368 AWG24, GRAY WIRE, REAR FAN ----- (-)
 - UL10368 AWG24, ORANGE WIRE, REAR FAN ----- (+)
 - UL10368 AWG26, GREEN WIRE, REAR FAN ----- (F00)
- THIS PRODUCT IS ROHS COMPLAINT

PART NO:

DELTA MODEL: GFC0948SS-00F4N

10. FREQUENCY GENERATOR (FG) SIGNAL:

10-1. OUTPUT CIRCUIT - OPEN COLLECTOR MODE:

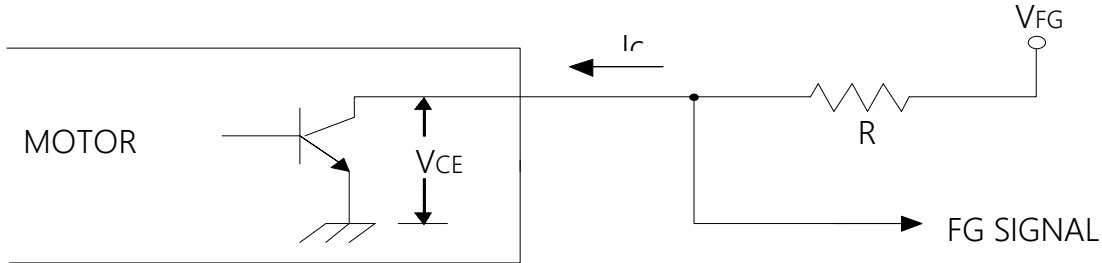

CAUTION:

THE LEAD WIRE OF FG SIGNAL CAN NOT TOUCH
THE LEAD WIRE OF POSITIVE OR NEGATIVE.

10-2. SPECIFICATION:

$V_{CE(sat)} = 0.5V$ MAX.

$V_{FG} = 60.0$ VDC MAX.

$I_c = 3mA$ MAX.

$R \geq V_{FG} / I_c$

10-3. FREQUENCY GENERATOR WAVEFORM:

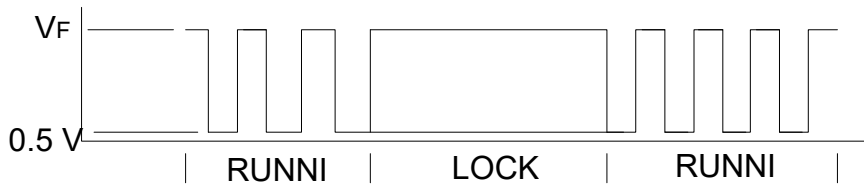

FAN RUNNING FOR 4 POLES

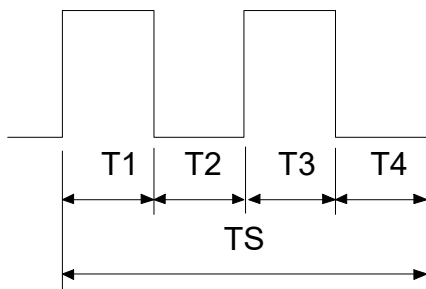

BLADE LOCKED

OR

$T1=T2=T3=T4=1/4$

$N=R.P.M$

$TS=60/N(SEC)$

*VOLTAGE LEVEL AFTER BLADE LOCKED

*4 POLES

PART NO:

DELTA MODEL: GFC0948SS-00F4N

11. PWM CONTROL SIGNAL:

SIGNAL VOLTAGE RANGE: 0~15.0VDC

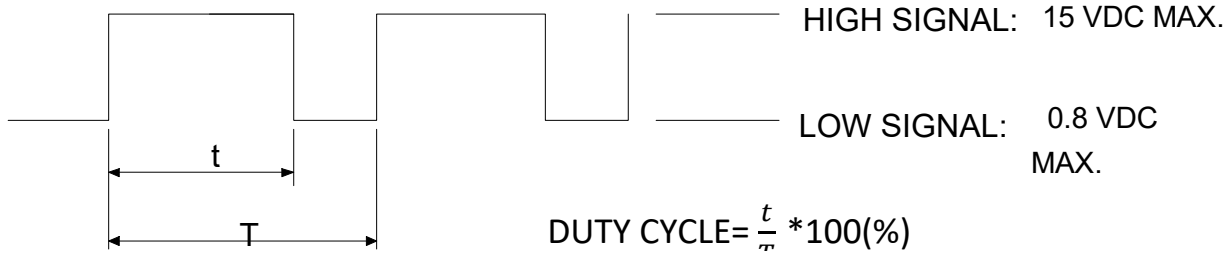

- * THE PREFERRED OPERATING POINT FOR THE FAN IS 25K HZ.
- * AT 100% DUTY CYCLE, THE ROTOR WILL SPIN AT MAXIMUM SPEED.
- * AT 0% DUTY CYCLE, THE ROTOR WILL SPIN AT MINIMUM SPEED.
- * WITH CONTROL SIGNAL LEAD DISCONNECTED, THE FAN WILL SPIN AT MAXIMUM SPEED.
- * AT 25KHZ 0% DUTY CYCLE, THE FAN WILL BE ABLE TO START FROM A DEAD STOP.
- * THE FAN SPEED CONTROL IS CLOSED-LOOP.

12. SPEED VS PWM CONTROL SIGNAL:

(RAW FAN AT 25°C, RATED VOLTAGE & PWM SIGNAL AS FOLLOW)

DUTY CYCLE (%)	SPEED R.P.M. (REF.)		TYP. TOTAL CURRENT (A)
	FRONT	REAR	
100	11000±10%	11200±10%	1.0A
0	1100±300	1150±300	0.05A

13. PWM CONTROL LEAD WIRE INPUT IMPEDANCE

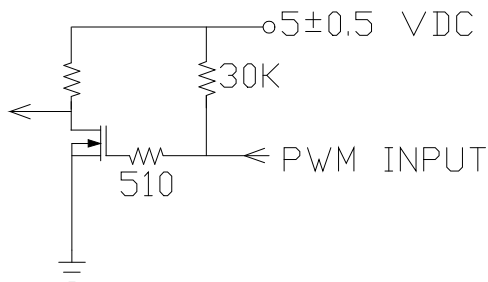



Application Notice

- 1. Delta will not guarantee the performance of the products if the application condition falls outside the parameters set forth in the specification.**
- 2. A written request should be submitted to Delta prior to approval if deviation from this specification is required.**
- 3. Please exercise caution when handling fans. Damage may be caused when pressure is applied to the impeller, if the fans are handled by the lead wires, or if the fan was hard-dropped to the production floor.**
- 4. Except as pertains to some special designs, there is no guarantee that the products will be free from any such safety problems or failures as caused by the introduction of powder, droplets of water or encroachment of insect into the hub.**
- 5. The above-mentioned conditions are representative of some unique examples and viewed as the first point of reference prior to all other information.**
- 6. It is very important to establish the correct polarity before connecting the fan to the power source. Positive (+) and Negative (-). Damage may be caused to the fans if connection is with reverse polarity, if there is no foolproof method to protect against such error specifically mentioned in this spec.**
- 7. Delta fans without special protection are not suitable where any corrosive fluids are introduced to their environment.**
- 8. Please ensure all fans are stored according to the storage temperature limits specified. Do not store fans in a high humidity environment. We highly recommend performance testing is conducted before shipping, if the fans have been stored over 6 months.**
- 9. Not all fans are provided with the Lock Rotor Protection feature. If you impair the rotation of the impeller for the fans that do not have this function, the performance of those fans will lead to failure.**
- 10. Please be cautious when mounting the fan. Incorrect mounting of fans may cause excess resonance, vibration and subsequent noise.**
- 11. It is important to consider safety when testing the fans. A suitable fan guard should be fitted to the fan to guard against any potential for personal injury.**
- 12. Except where specifically stated, all tests are carried out at room (ambient) temperature and relative humidity conditions of 25°C, 65% RH. The test value is only for fan performance itself.**
- 13. Be certain to connect an “ 4.7μF or greater” capacitor to the fan externally when the application calls for using multiple fans in parallel, to avoid any unstable power.**