



## SPECIFICATION FOR APPROVAL

Customer : \_\_\_\_\_  
Description : DC FAN \_\_\_\_\_  
Customer Part No. : \_\_\_\_\_ REV. : \_\_\_\_\_  
Delta Model No. : EFB0612HHAF99 \_\_\_\_\_ REV. : 01 \_\_\_\_\_  
Sample Issue No. : \_\_\_\_\_  
Sample Issue Date : MAR.13 2019 \_\_\_\_\_

PLEASE SEND ONE COPY OF THIS SPECIFICATION BACK AFTER YOU SIGNED APPROVAL FOR PRODUCTION PRE-ARRANGMENT.

APPROVED BY:

DATE :

DELTA ELECTRONICS, INC.  
TAOYUAN PLANT  
252, SHANG YING ROAD, KUEI SAN INDUSTRIAL ZONE  
TAOYUAN SHIEN, TAIWAN, R.O.C.  
TEL:886-(0)3-3591968  
FAX:886-(0)3-3591991

Delta Electronics, Inc.  
No.252, Shanying Rd., Guishan Dist.,  
Taoyuan City 333, Taiwan (R.O.C.)

TEL : 886-(0)3-3591968  
FAX : 886-(0)3-3591991

## STATEMENT OF DEVIATION

NONE

DESCRIPTION:

Delta Electronics, Inc.  
No.252, Shanying Rd., Guishan Dist.,  
Taoyuan City 333, Taiwan (R.O.C.)

TEL : 886-(0)3-3591968  
FAX : 886-(0)3-3591991

## Specification For Approval

Customer : \_\_\_\_\_

Description : DC FAN  
\_\_\_\_\_

Customer P/N : \_\_\_\_\_

rev. : \_\_\_\_\_

Delta model no. : EFB0612HHAF99  
\_\_\_\_\_

Delta Safety Model No.: EFB0612HHA  
\_\_\_\_\_

Sample revision. : 01  
\_\_\_\_\_

Issue no.: \_\_\_\_\_

Sample issue date : MAR.13 2019  
\_\_\_\_\_

Quanti EFB  
\_\_\_\_\_

### 1. SCOPE:

THIS SPECIFICATION DEFINES THE ELECTRICAL AND MECHANICAL CHARACTERISTICS OF THE DC BRUSHLESS BLOWER FAN.

### 2. CHARACTERS:

ITEM	DESCRIPTION
RATED VOLTAGE	12 V
OPERATION VOLTAGE	5.0-13.2 VDC VDC
INPUT CURRENT(AVG.) # (MEAN CURRENT)	0.20 (MAX. 0.25) A SAFETY CURRENT ON LABEL :0.25A
INPUT POWER(AVG.)	2.40 (MAX. 3.00) W
SPEED	4800 ± 10% R.P.M.
MAX. AIR FLOW (AT ZERO STATIC PRESSURE) (WITH CUSTOMER'S COVER)	0.426 (MIN. 0.383) M <sup>3</sup> /MIN. 15.03 (MIN. 13.53) CFM
MAX. AIR PRESSURE (AT ZERO AIRFLOW) (WITH CUSTOMER'S COVER)	3.272 (MIN. 2.650) mmH <sub>2</sub> O 0.129 (MIN. 0.104) inchH <sub>2</sub> O
ACOUSTICAL NOISE (AVG.) (FAN ONLY)	39.0 (MAX. 43.0) dB-A
INSULATION TYPE	UL: CLASS A
INSULATION STRENGTH	10 MEG OHM MIN. AT 500 VDC (BETWEEN FRAME AND (+) TERMINAL)
DIELECTRIC STRENGTH	5 mA MAX. AT 500 VAC 50/60 Hz ONE MINUTE, (BETWEEN FRAME AND (+) TERMINAL)

# : THE MAX VALUE OF CONSUMING CURRENT DOES NOT REPRESENT THE PEAK VALUE  
THE PEAK VALUE NEED MEASURE BY OSCILLOSCOPE.

PART NO:

DELTA MODEL: EFB0612HHAF99

LIFE EXPECTANCE (L10) (AT LABEL VOLTAGE)	50,000 HOURS CONTINUOUS OPERATION AT 40 °C WITH 15 ~ 65 %RH.
ROTATION	COUNTERCLOCKWISE VIEW FROM NAME PLATE SIDE.
LOCK ROTOR SHUT DOWN	THE CURRENT WILL SHUT DOWN, WHEN ROTOR LOCKED AND FIXED.

NOTES:

1. ALL READINGS ARE MEASURED AFTER STABLY WARMING UP THROUGH 10 MINUTES.
2. STANDARD AIR PROPERTY IS AIR AT (Td) 25°C TEMPERATURE, (RH) 65% RELATIVE HUMIDITY , AND (Pb) 760 mmHg BAROMETRIC PRESSURE.
3. THE VALUES WRITTEN IN PARENS , ( ), ARE LIMITED SPEC.
4. ACOUSTICAL NOISE MEASURING CONDITION:

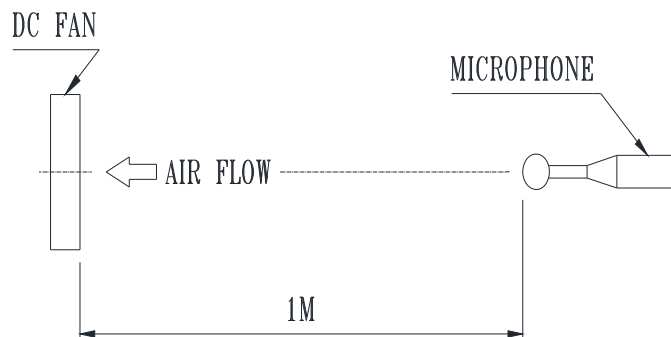

NOISE IS MEASURED AT RATED VOLTAGE IN FREE AIR IN ANECHOIC CHAMBER WITH B & K SOUND LEVEL METER WITH MICROPHONE AT A DISTANCE OF ONE METER FROM THE FAN INTAKE.

---

PART NO:

---

DELTA MODEL: EFB0612HHAF99

---

3. MECHANICAL:

- 3-1. DIMENSIONS----- SEE DIMENSIONS DRAWING
- 3-2. FRAME----- PLASTIC UL: 94V-0
- 3-3. IMPELLER----- PLASTIC UL: 94V-0
- 3-4. BEARING SYSTEM----- TWO BALL BEARINGS
- 3-5. WEIGHT----- 17.0 GRAMS(REF.)

4. ENVIRONMENTAL:

- 4-1. OPERATING TEMPERATURE----- -10 TO +60 DEGREE C
- 4-2. STORAGE TEMPERATURE----- -40 TO +75 DEGREE C
- 4-3. OPERATING HUMIDITY----- 5 TO 90 % RH
- 4-4. STORAGE HUMIDITY----- 5 TO 95 % RH

5. PROTECTION:

5-1. LOCKED ROTOR PROTECTION

IMPEDANCE OF MOTOR WINDING PROTECTS MOTOR FROM FIRE IN  
96 HOURS OF LOCKED ROTOR CONDITION AT THE RATED VOLTAGE.

5-2. POLARITY PROTECTION

BE CAPABLE OF WITHSTANDING IF REVERSE CONNECTION FOR POSITIVE  
AND NEGATIVE LEADS.

6. RE OZONE DEPLETING SUBSTANCES:

- 6-1. NO CONTAINING PBBs, PBBOs, CFCs, PBBEs, PBDPEs AND HCFCs.

7. PRODUCTION LOCATION

- 7-1. PRODUCTS WILL BE PRODUCED IN CHINA OR THAILAND.

PART NO:

DELTA MODEL: EFB0612HHAF99

8. P & Q CURVE:

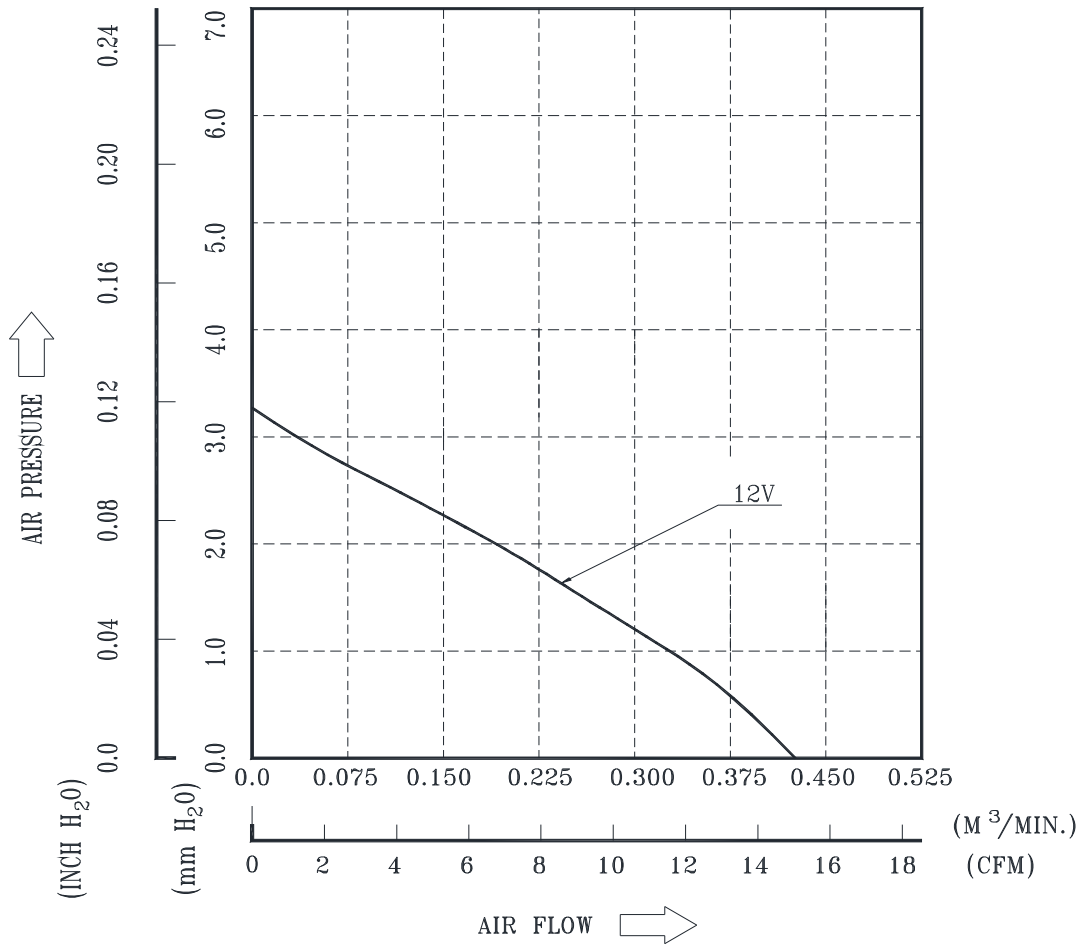

\*TEST CONDITION: INPUT VOLTAGE-----OPERATION VOLTAGE  
TEMPERATURE-----ROOM TEMPERATURE  
HUMIDITY-----65%RH

PART NO:

DELTA MODEL: EFB0612HHAF99

9. DIMENSION DRAWING:

LABEL:

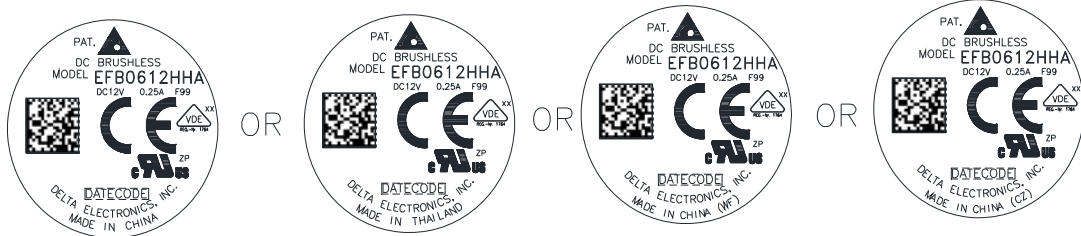

DRAWING:

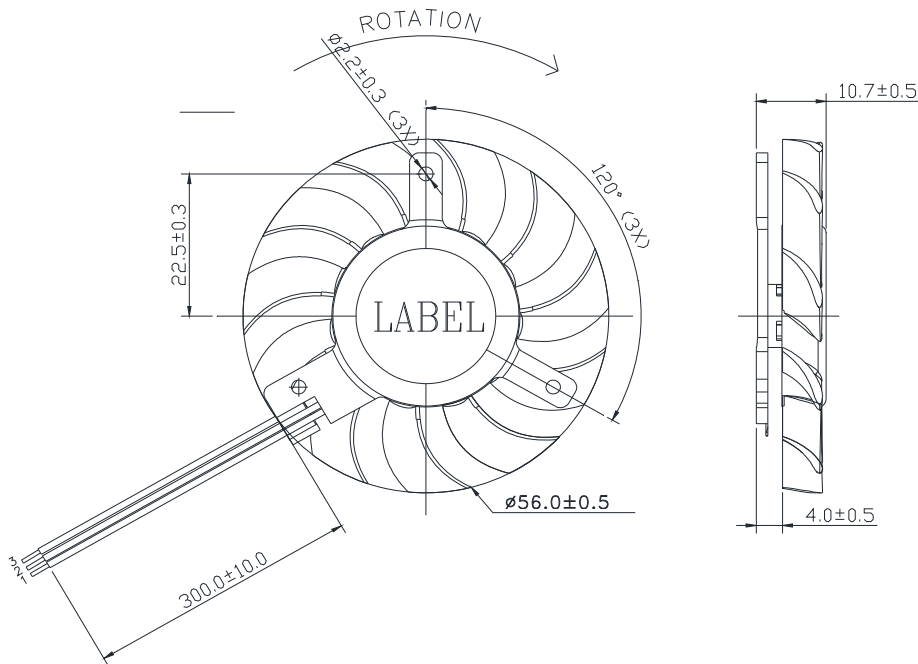

NOTES:

1. LEAD WIRE: UL:10368 AWG#26  
PIN 1: RED WIRE ----- (+)  
PIN 2: BLACK WIRE ----- (-)  
PIN 3: BLUE WIRE ----- (F00)
2. UNIT : mm
3. THIS PRODUCT IS RoHS COMPLIANT.
4. DELTA'S RESTRICTIONS ON HALOGEN APPLY ONLY TO BROMINATED AND CHLORINATED COMPOUNDS. NO OTHER HALOGEN IS RESTRICTED. SUBSTANCES RESTRICTIONS FOR HALOGEN-FREE (INCLUDE FAN PLASTIC PARTS, PWB BOARD, IC, ELECTRICAL MATERIALS & CABLE ASSY),
  - a. BROMINE (Br) < 900 PPM,
  - b. CHLORINE (Cl) < 900 PPM
  - c. (Br) + (Cl) < 1500 PPM.

PART NO:

DELTA MODEL: EFB0612HHAF99

10. FREQUENCY GENERATOR (FG) SIGNAL:

10-1. OUTPUT CIRCUIT - OPEN COLLECTOR MODE:

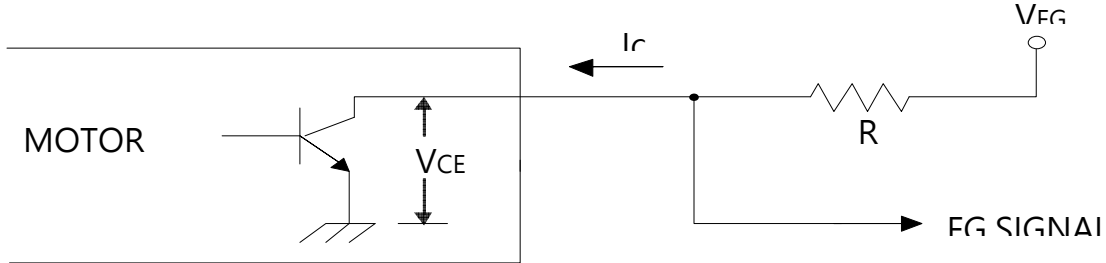

CAUTION:

THE FG SIGNAL LEAD WIRE MUST BE KEPT AWAY FROM "+" LEAD WIRE & "-" LEAD WIRE.

10-2. SPECIFICATION:

$V_{CE(sat)} = 0.5V \text{ MAX.}$

$V_{FG} = 5.0 \text{ VDC TYP. (13.2V MAX.)}$

$I_c = 5mA \text{ MAX.}$

$R \geq V_{FG} / I_c$

10-3. FREQUENCY GENERATOR WAVEFORM:

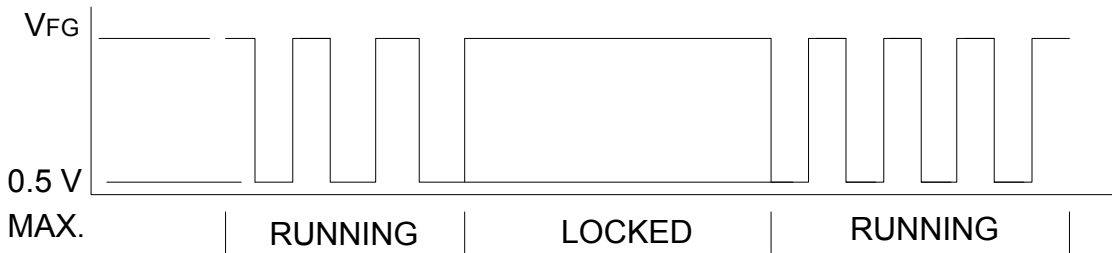

FAN RUNNING FOR 4 POLES

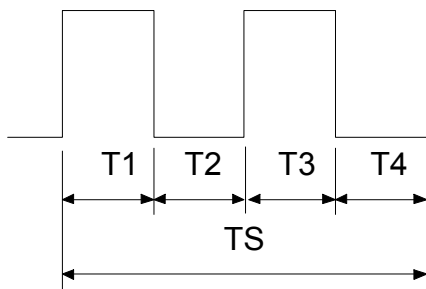

BLADE LOCKED

OR

$T1=T2=T3=T4=1/4$

$N=R.P.M$

$TS=60/N(SEC)$

\*VOLTAGE LEVEL AFTER BLADE LOCKED

\*4 POLES





## ***Application Notice***

- 1. Delta will not guarantee the performance of the products if the application condition falls outside the parameters set forth in the specification.**
- 2. A written request should be submitted to Delta prior to approval if deviation from this specification is required.**
- 3. Please exercise caution when handling fans. Damage may be caused when pressure is applied to the impeller, if the fans are handled by the lead wires, or if the fan was hard-dropped to the production floor.**
- 4. Except as pertains to some special designs, there is no guarantee that the products will be free from any such safety problems or failures as caused by the introduction of powder, droplets of water or encroachment of insect into the hub.**
- 5. The above-mentioned conditions are representative of some unique examples and viewed as the first point of reference prior to all other information.**
- 6. It is very important to establish the correct polarity before connecting the fan to the power source. Positive (+) and Negative (-). Damage may be caused to the fans if connection is with reverse polarity, if there is no foolproof method to protect against such error specifically mentioned in this spec.**
- 7. Delta fans without special protection are not suitable where any corrosive fluids are introduced to their environment.**
- 8. Please ensure all fans are stored according to the storage temperature limits specified. Do not store fans in a high humidity environment. We highly recommend performance testing is conducted before shipping, if the fans have been stored over 6 months.**
- 9. Not all fans are provided with the Lock Rotor Protection feature. If you impair the rotation of the impeller for the fans that do not have this function, the performance of those fans will lead to failure.**
- 10. Please be cautious when mounting the fan. Incorrect mounting of fans may cause excess resonance, vibration and subsequent noise.**
- 11. It is important to consider safety when testing the fans. A suitable fan guard should be fitted to the fan to guard against any potential for personal injury.**
- 12. Except where specifically stated, all tests are carried out at room (ambient) temperature and relative humidity conditions of 25°C, 65% RH. The test value is only for fan performance itself.**
- 13. Be certain to connect an “ 4.7μF or greater” capacitor to the fan externally when the application calls for using multiple fans in parallel, to avoid any unstable power.**