



## SPECIFICATION FOR APPROVAL

Customer : STD

Description : DC FAN

Customer Part No. \_\_\_\_\_

REV. : \_\_\_\_\_

Delta Model No. : EFB0424VHD-CP0

REV. : 02

Sample Issue No. : \_\_\_\_\_

Sample Issue Date : AUG.26 2020

PLEASE SEND ONE COPY OF THIS SPECIFICATION BACK AFTER YOU SIGNED APPROVAL FOR PRODUCTION PRE-ARRANGMENT.

APPROVED BY:

DATE :

DELTA ELECTRONICS, INC.  
TAOYUAN PLANT  
252, SHANGYING ROAD, GUISHAN INDUSTRIAL ZONE,  
TAOYUAN CITY 33341, TAIWAN  
TEL:886-(0)3-3591968  
FAX:886-(0)3-3591991

DELTA ELECTRONICS, INC.  
252, SHANGYING ROAD, GUISHAN INDUSTRIAL ZONE,  
TAOYUAN CITY 33341, TAIWAN

TEL : 886-(0)3-3591968  
FAX : 886-(0)3-3591991

## STATEMENT OF DEVIATION

NONE

DESCRIPTION:

DELTA ELECTRONICS, INC.  
252, SHANGYING ROAD, GUISHAN INDUSTRIAL ZONE,  
TAOYUAN CITY 33341, TAIWAN

TEL : 886-(0)3-3591968  
FAX : 886-(0)3-3591991

## **SPECIFICATION FOR APPROVAL**

Customer : STD

Description : DC FAN

Customer P/N :

rev. :

Delta model no. : EFB0424VHD-CP0

Delta Safety Model No.: EFB0424VHD-C

Sample revision. : 02

Issue no.:

Sample issue date : AUG.26 2020

Quantity :

### 1. SCOPE:

THIS SPECIFICATION DEFINES THE ELECTRICAL AND MECHANICAL CHARACTERISTICS OF THE DC BRUSHLESS AXIAL FLOW FAN.

### 2. CHARACTERS:

ITEM	DESCRIPTION
RATED VOLTAGE	24.0 V
OPERATION VOLTAGE RANGE	14.0 - 26.5 VDC
INPUT CURRENT(AVG.) (AT RATED VOLTAGE)	0.06(MAX. 0.08) A SAFETY CURRENT ON LABEL : 0.12A
INPUT POWER(AVG.) (AT RATED VOLTAGE)	1.44 (MAX. 1.92) W
SPEED (AT RATED VOLTAGE)	9000 R.P.M.±15%
MAX. AIR FLOW (AT ZERO STATIC PRESSURE)	0.266 (MIN. 0.226) M <sup>3</sup> /MIN. 9.398 (MIN. 7.988) CFM
MAX. AIR PRESSURE (AT ZERO AIRFLOW)	9.346 (MIN. 6.752) mmH <sub>2</sub> O 0.368 (MIN. 0.265) inchH <sub>2</sub> O
ACOUSTICAL NOISE (AVG.)	37.3(MAX. 41.3) dB-A
INSULATION TYPE	UL: CLASS A
INSULATION STRENGTH	10 MEG OHM MIN. AT 500 VDC (BETWEEN FRAME AND (+) TERMINAL)
DIELECTRIC STRENGTH	5 mA MAX. AT 500 VAC 50/60 Hz ONE MINUTE, (BETWEEN FRAME AND (+) TERMINAL)

(continued)

PART NO:

DELTA MODEL: EFB0424VHD-CP0

LIFE EXPECTANCE (L10) (AT LABEL VOLTAGE)	70,000 HOURS CONTINUOUS OPERATION AT 40 ° C WITH 15 ~ 65 %RH.
ROTATION	CLOCKWISE VIEW FROM NAME PLAT SIDE
LOCK ROTOR PROTECTION	THE CURRENT WILL SHUT DOWN TO ZERO WHILE FAN'S BLADE IS LOCKED.

NOTES:

1. THE MEASUREMENT READINGS ARE RECORDED AFTER STABLY WARMING UP IN 10 MINUTES.
2. THE TEST IS PERFORMED AT (Td) 25°C TEMPERATURE, (RH) 65% RELATIVE HUMIDITY , AND (Pb) 760 mmHg BAROMETRIC PRESSURE.
3. THE MEASUREMENT IS FOLLOWED ACCORDING TO SPEC WRITTEN IN PARENS ( ).
4. THE ACOUSTICAL NOISE MEASUREMENT SETUP AS BELOW:

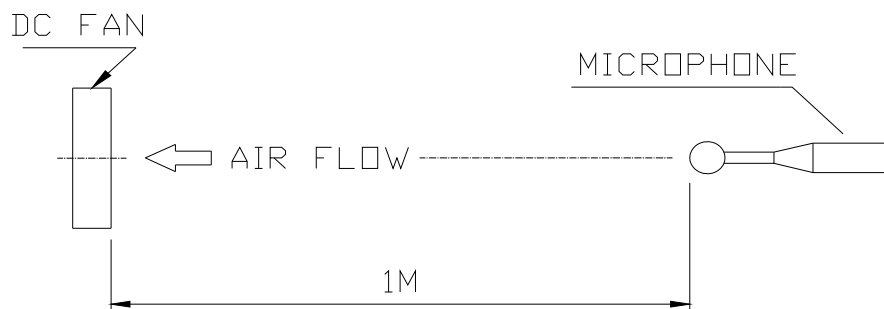

NOISE IS MEASURED AT RATED VOLTAGE IN FREE AIR IN SEMI-ANECHOIC CHAMBER WITH MICROPHONE AT A DISTANCE OF ONE METER FROM THE FAN INTAKE.

---

PART NO:

---

DELTA MODEL: EFB0424VHD-CP0

---

3. MECHANICAL:

- 3-1. DIMENSIONS----- SEE DIMENSIONS DRAWING
- 3-2. FRAME----- PLASTIC UL: 94V-0
- 3-3. IMPELLER----- PLASTIC UL: 94V-0
- 3-4. BEARING SYSTEM----- TWO BALL BEARINGS
- 3-5. WEIGHT----- 33.0 GRAMS(REF.)

4. ENVIRONMENTAL:

- 4-1. OPERATING TEMPERATURE----- -10 TO +70 DEGREE C
- 4-2. STORAGE TEMPERATURE----- -40 TO +75 DEGREE C
- 4-3. OPERATING HUMIDITY----- 5 TO 90 % RH
- 4-4. STORAGE HUMIDITY----- 5 TO 95 % RH

5. PROTECTION:

- 5-1. LOCKED ROTOR PROTECTION  
FAN'S PROTECTION WITHOUT FIRE IS PERFORMED IN 96 HOURS  
WHILE LOCKED ROTOR AT THE RATED VOLTAGE.
- 5-2. POLARITY PROTECTION  
BE CAPABLE OF WITHSTANDING IF REVERSE CONNECTION FOR  
POSITIVE AND NEGATIVE LEADS.

6. RE OZONE DEPLETING SUBSTANCES:

- 6-1. NO CONTAINING PBBs, PBBOs, CFCs, PBBEs, PBDPEs AND HCFCs.

7. PRODUCTION LOCATION

- 7-1. PRODUCTS WILL BE PRODUCED IN CHINA OR THAILAND.

PART NO:

DELTA MODEL: EFB0424VHD-CP0

8. P & Q CURVE:

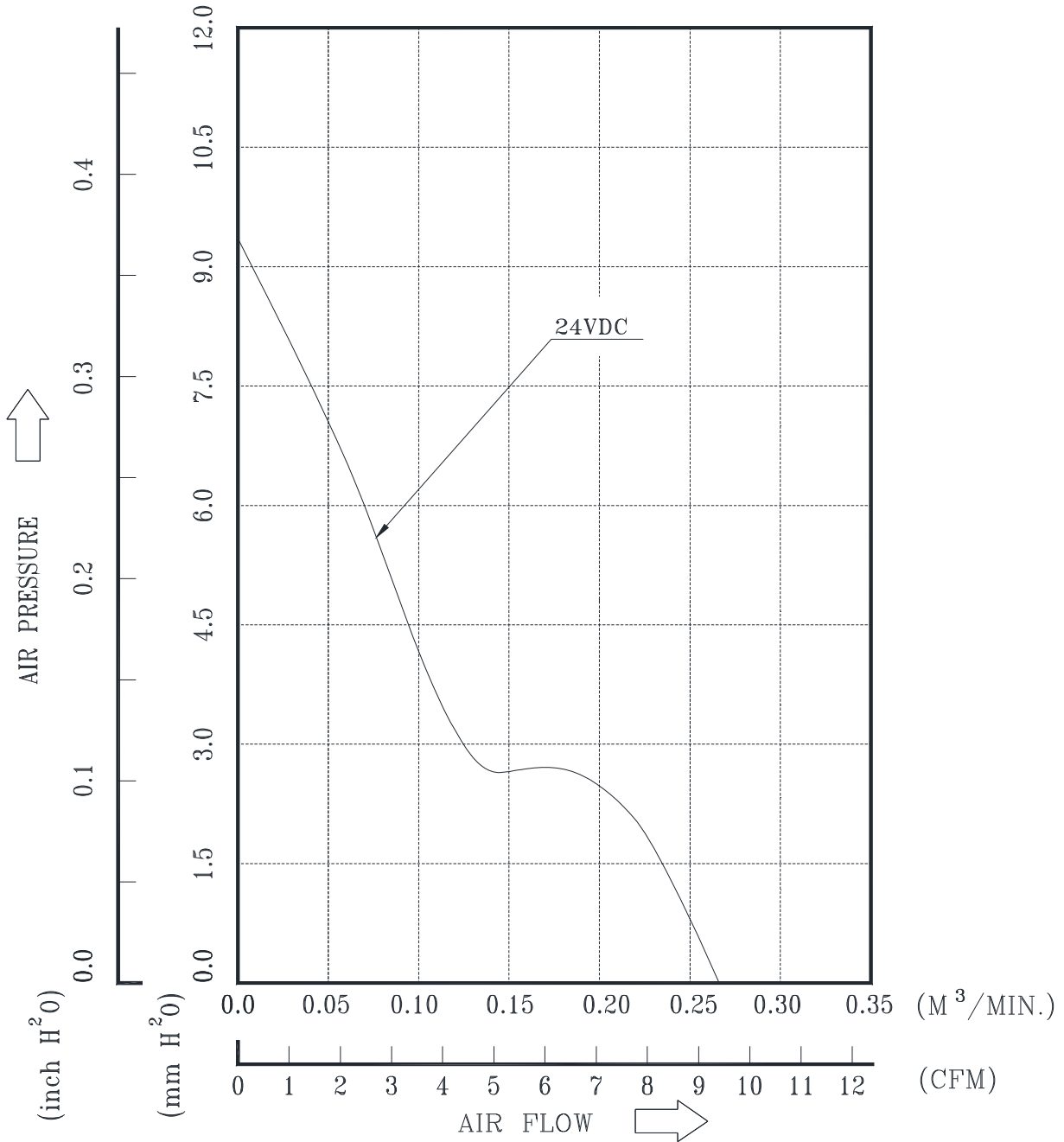

\*TEST CONDITION: INPUT VOLTAGE-----OPERATION VOLTAGE  
TEMPERATURE-----ROOM TEMPERATURE  
HUMIDITY-----65%RH

PART NO:

DELTA MODEL: EFB0424VHD-CP0

9. DIMENSION DRAWING:

LABEL:

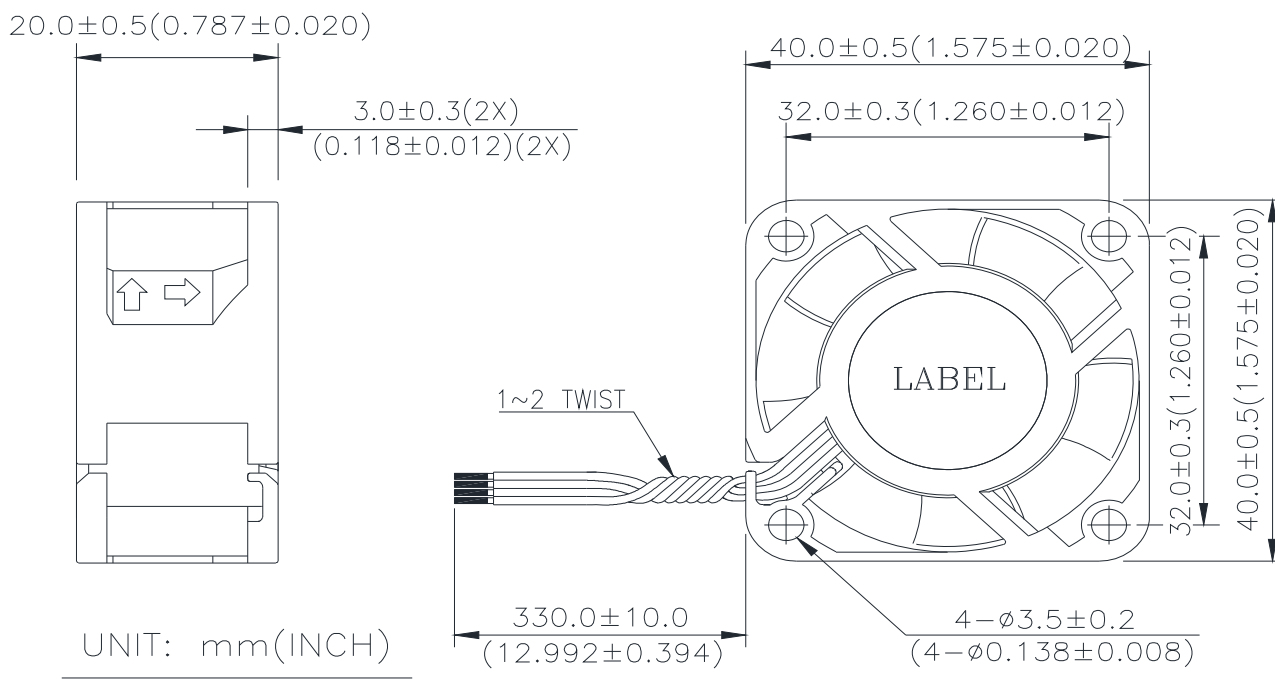

NOTES:

1. LEAD WIRE: UL1061 AWG#26  
RED WIRE----(+)  
BLACK WIRE----(-)  
BLUE WIRE----(F00)  
YELLOW WIRE----(PWM)
2. THIS PRODUCT IS ROHS COMPLIANT.

PART NO:

DELTA MODEL: EFB0424VHD-CP0

10.FREQUENCY GENERATOR (FG) SIGNAL:

10-1. OUTPUT CIRCUIT - OPEN COLLECTOR MODE:

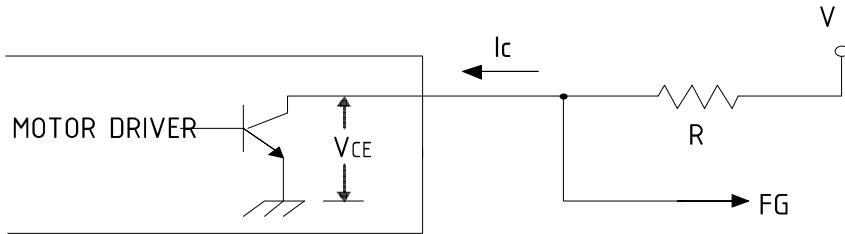

CAUTION:

THE LEAD WIRE OF FG SIGNAL CAN NOT TOUCH THE LEAD WIRE OF POSITIVE OR NEGATIVE.

10-2. SPECIFICATION:

$V_{FG} = 5.0$  TYP.( $V_{CC}$  MAX.)

$V_{CE} = 0.5V$  MAX.

$I_c = 5mA$  MAX.

$R \geq V_{FG} / I_c$

10-3. FREQUENCY GENERATOR WAVEFORM:

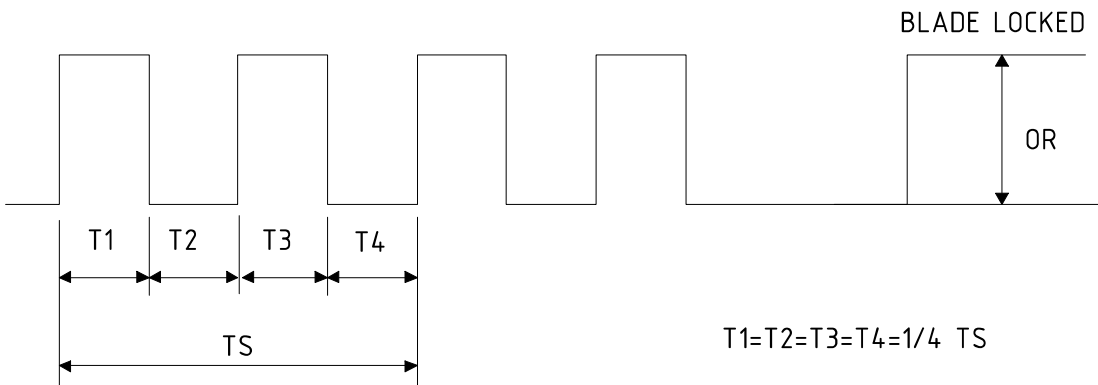
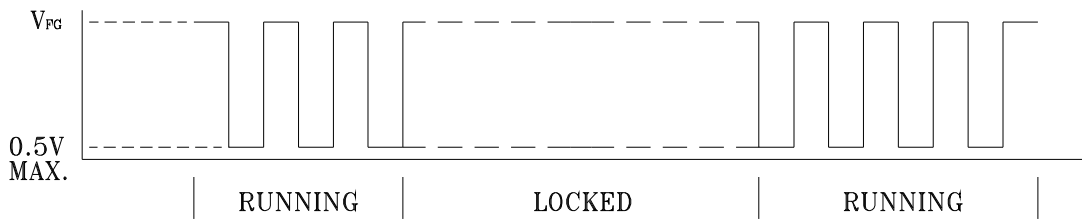

$N=R.P.M$

$TS=60/N(SEC)$

\*VOLTAGE LEVEL AFTER BLADE LOCKED

\*4 POLES



---

PART NO:

---

DELTA MODEL: EFB0424VHD-CP0

---

11.PWM CONTROL SIGNAL:

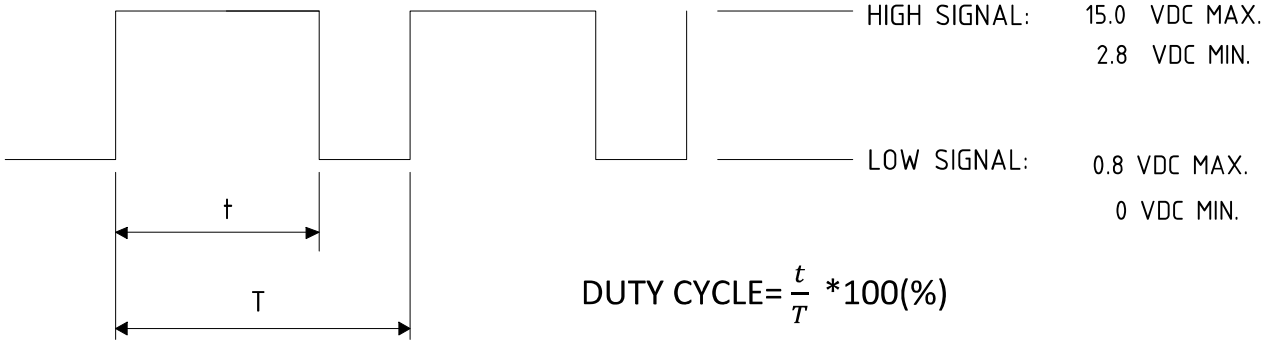

- \* THE OPERATING FREQUENCY IS 25KHz.
- \* AT 100% DUTY CYCLE, THE FAN WILL SPIN AT MAXIMUM SPEED.
- \* AT 0% DUTY CYCLE, THE FAN WILL STOP SPINNING.
- \* THE FAN WILL SPIN AT MAXIMUM SPEED WHILE CONTROL SIGNAL LEAD IS DISCONNECTED.
- \* THE FAN WILL BE ABLE TO START FROM A DEAD STOP WHILE PWM SET AT 25KHZ 20% DUTY CYCLE & RATED VOLTAGE .

12. SPEED VS PWM CONTROL SIGNAL:  
(AT 25°C, RATED VOLTAGE & PWM SIGNAL AS FOLLOW)

\*PWM SIGNAL  
PWM FREQUENCY = 25KHz

DUTY CYCLE (%)	SPEED (R.P.M.)	CURRENT (A) (AVG.)
100	9000±15%	0.06(MAX. 0.08)
0	0	0.01(MAX. 0.02)

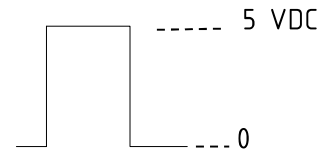

PART NO:

DELTA MODEL: EFB0424VHD-CP0

### 13. FAN CABLE ADDITIONAL PROCESS OUTSIDE DELTA

#### 13-1. HANDLING :

13-1-1. DO NOT PRESS ROTOR OR PULL CABLE IN ANY PROCESS.



13-1-2. WEARING ELECTROSTATIC GLOVES BEFORE WORKING, MAKE SURE HOUSING ASSAMBLING MECHINE, WORKING TABLE WITH ELECTROSTATIC PROTECTION.

13-1-3. DO NOT WEAR OR DROP THE FAN DURING ALL PROCESS, PLEASE SCRAPE DROOPED FAN TO AVOID BEARING DAMAGE.

#### 13-2. TESTING :

13-2-1. MAKE SURE FAN SPEED AND FUNCTION WORKS WELL AFTER ASSAMBLY.



#### 13-3. PACKING:

13-3-1. BE SURE OF FAN DERECTION AND HOUSING POSITION, CAN'T INTERFER CARTON OR POTTION OR OTHER MATERIAL.

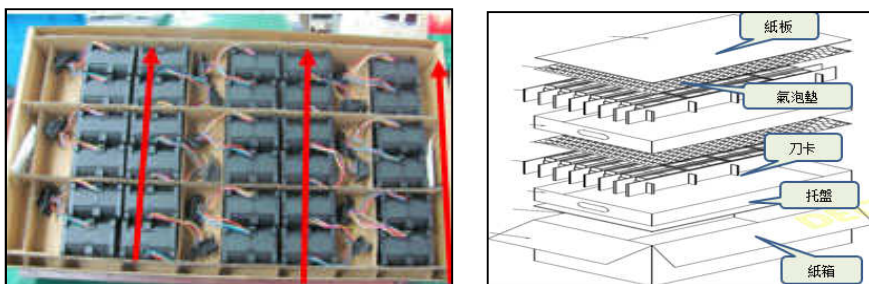

13-3-2. MAKE SURE DESICCANT, QUANTITY AND P/N IS CORRECT BEFORE PACKING.





## ***Application Notice***

- 1. Delta will not guarantee the performance of the products if the application condition falls outside the parameters set forth in the specification.**
- 2. A written request should be submitted to Delta prior to approval if deviation from this specification is required.**
- 3. Please exercise caution when handling fans. Damage may be caused when pressure is applied to the impeller, if the fans are handled by the lead wires, or if the fan was hard-dropped to the production floor.**
- 4. Except as pertains to some special designs, there is no guarantee that the products will be free from any such safety problems or failures as caused by the introduction of powder, droplets of water or encroachment of insect into the hub.**
- 5. The above-mentioned conditions are representative of some unique examples and viewed as the first point of reference prior to all other information.**
- 6. It is very important to establish the correct polarity before connecting the fan to the power source. Positive (+) and Negative (-). Damage may be caused to the fans if connection is with reverse polarity, if there is no foolproof method to protect against such error specifically mentioned in this spec.**
- 7. Delta fans without special protection are not suitable where any corrosive fluids are introduced to their environment.**
- 8. Please ensure all fans are stored according to the storage temperature limits specified. Do not store fans in a high humidity environment. We highly recommend performance testing is conducted before shipping, if the fans have been stored over 6 months.**
- 9. Not all fans are provided with the Lock Rotor Protection feature. If you impair the rotation of the impeller for the fans that do not have this function, the performance of those fans will lead to failure.**
- 10. Please be cautious when mounting the fan. Incorrect mounting of fans may cause excess resonance, vibration and subsequent noise.**
- 11. It is important to consider safety when testing the fans. A suitable fan guard should be fitted to the fan to guard against any potential for personal injury.**
- 12. Except where specifically stated, all tests are carried out at room (ambient) temperature and relative humidity conditions of 25°C, 65% RH. The test value is only for fan performance itself.**
- 13. Be certain to connect an “ 4.7μF or greater” capacitor to the fan externally when the application calls for using multiple fans in parallel, to avoid any unstable power.**