

DELTA ELECTRONICS, INC.
 252, SHANG YING ROAD, KUEI SAN
 TAOYUAN HSIEN 333, TAIWAN, R. O. C.

TEL : 886-(0)3-3591968
 FAX : 886-(0)3-3591991

SPECIFICATION FOR APPROVAL

Customer:

Description:	DC FAN
Customer P/N:	REV:
Delta Model NO.:	AFB0812SHB-F00
Sample Rev:	00 Issue NO:
Sample Issue Date:	JUN.30.2004. Quantity:

1. SCOPE:

THIS SPECIFICATION DEFINES THE ELECTRICAL AND MECHANICAL CHARACTERISTICS OF THE DC BRUSHLESS AXIAL FLOW FAN. THE FAN MOTOR IS WITH TWO PHASES AND FOUR POLES.

2. CHARACTERS:

ITEM	DESCRIPTION
RATED VOLTAGE	12 VDC
OPERATION VOLTAGE	7.0 - 13.8 VDC
START VOLTAGE (ENVIRONMENT TEMPERATURE AT 25°C)	≤ 4.0 VDC
INPUT CURRENT	0.27 (MAX. 0.40) A
INPUT POWER	3.24 (MAX. 4.80) W
SPEED	4000 R.P.M. (REF.)
MAX. AIR FLOW (AT ZERO STATIC PRESSURE)	1.210(MIN. 1.090) M ³ /MIN. 42.73 (MIN. 38.49) CFM
MAX.AIR PRESSURE (AT ZERO AIRFLOW)	5.49 (MIN. 4.47) mmH ₂ O 0.216 (MIN. 0.176) inchH ₂ O
ACOUSTICAL NOISE (AVG.)	42.5 (MAX. 45.0) dB-A
INSULATION TYPE	UL: CLASS A

(continued)

PART NO:

DELTA MODEL: AFB0812SHB-F00

INSULATION STRENGTH	10 MEG OHM MIN. AT 500 VDC (BETWEEN FRAME AND (+) TERMINAL)
DIELECTRIC STRENGTH	5 mA MAX. AT 500 VAC 60 Hz ONE MINUTE, (BETWEEN FRAME AND (+) TERMINAL)
EXTERNAL COVER	OPEN TYPE
LIFE EXPECTANCE	70,000 HOURS CONTINUOUS OPERATION AT 40 °C WITH 15 ~ 65 %RH.
ROTATION	CLOCKWISE VIEW FROM NAME PLATE SIDE
OVER CURRENT SHUT DOWN	THE CURRENT WILL SHUT DOWN WHEN LOCKING ROTOR.
LEAD WIRE	UL 1007 -F- AWG #24 BLACK WIRE NEGATIVE(-) RED WIRE POSITIVE(+) BLUE WIRE FREQUENCY(-F00)

- NOTES: 1. ALL READINGS ARE MEASURED AFTER STABLY WARMING UP THROUGH 10 MINUTES.
2. THE VALUES WRITTEN IN PARENS , (), ARE LIMITED SPEC.
3. ACOUSTICAL NOISE MEASURING CONDITION:

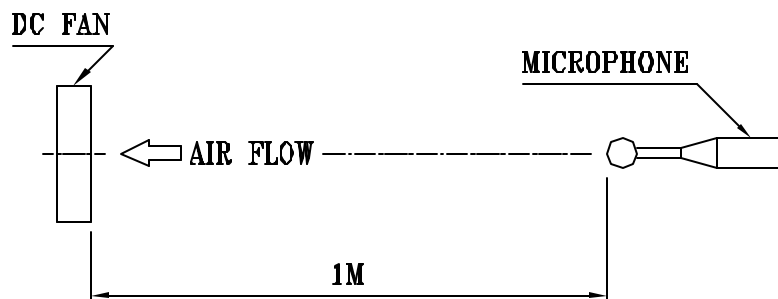

NOISE IS MEASURED AT RATED VOLTAGE IN FREE AIR IN ANECHOIC CHAMBER WITH B & K SOUND LEVEL METER WITH MICROPHONE AT A DISTANCE OF ONE METER FROM THE FAN INTAKE.

PART NO:

DELTA MODEL: AFB0812SHB-F00

3. MECHANICAL:

- 3-1. DIMENSIONS ----- SEE DIMENSIONS DRAWING
- 3-2. FRAME ----- PLASTIC UL: 94V-0
- 3-3. IMPELLER ----- PLASTIC UL: 94V-0
- 3-4. BEARING SYSTEM ----- TWO BALL BEARINGS
- 3-5. WEIGHT ----- 58 GRAMS

4. ENVIRONMENTAL:

- 4-1. OPERATING TEMPERATURE ----- -10 TO +70 DEGREE C
- 4-2. STORAGE TEMPERATURE ----- -40 TO +75 DEGREE C
- 4-3. OPERATING HUMIDITY ----- 5 TO 90 % RH
- 4-4. STORAGE HUMIDITY ----- 5 TO 95 % RH

5. PROTECTION:

5-1. LOCKED ROTOR PROTECTION

IMPEDANCE OF MOTOR WINDING PROTECTS MOTOR FROM FIRE IN 96 HOURS OF LOCKED ROTOR CONDITION AT THE RATED VOLTAGE.

5-2. POLARITY PROTECTION

BE CAPABLE OF WITHSTANDING IF REVERSE CONNECTION FOR POSITIVE AND NEGATIVE LEADS.

6. RE OZONE DEPLETING SUBSTANCES:

- 6-1. NO CONTAINING PBBs, PBBOs, CFCs, PBBEs, PBDPEs AND HCFCs.

7. PRODUCTION LOCATION

- 7-1. PRODUCTS WILL BE PRODUCED IN CHINA OR THAILAND OR TAIWAN.

PART NO:

DELTA MODEL: AFB0812SHB-F00

8. BASIC RELIABILITY REQUIREMENT:

- 8-1. THERMAL CYCLING LOW TEMPERATURE: -40°C
 HIGH TEMPERATURE: +80°C
 SOAK TIME: 30 MINUTES
 TRANSITION TIME < 5 MINUTES
 DUTY CYCLES: 5
- 8-2. HUMIDITY EXPOSURE TEMPERATURE: +25°C ~ +65°C
 HUMIDITY: 90-98% RH @ +65°C
 FOR 4 HOURS/CYCLE
 POWER: NON-OPERATING
 TEST TIME: 168 HOURS
- 8-3. VIBRATION TEMPERATURE: +25°C
 ORIENTATION: X, Y, Z
 POWER: NON-OPERATING
 VIBRATION LEVEL: OVERALL $g_{RMS}=3.2$
- | FREQUENCY(Hz) | PSD(G^2/Hz) |
|---------------|-----------------|
| 10 | 0.040 |
| 20 | 0.100 |
| 40 | 0.100 |
| 800 | 0.002 |
| 1000 | 0.002 |
- TEST TIME: 2 HOURS ON EACH ORIENTATION
- 8-4. MECHANICAL SHOCK TEMPERATURE: +20°C
 ORIENTATION: X, Y, Z
 POWER: NON-OPERATING
 ACCELERATION: 20 G MIN.
 PULSE: 11 ms HALF-SINE WAVE
 NUMBER OF SHOCKS: 5 SHOCKS
 FOR EACH DIRECTION
- 8-5. LIFE TEMPERATURE: MAX , OPERATING TEMPERATURE
 POWER: OPERATING
 DURATION: 1000 HOURS MIN.

PART NO:

DELTA MODEL: AFB0812SHB-F00

9. P & Q CURVE:

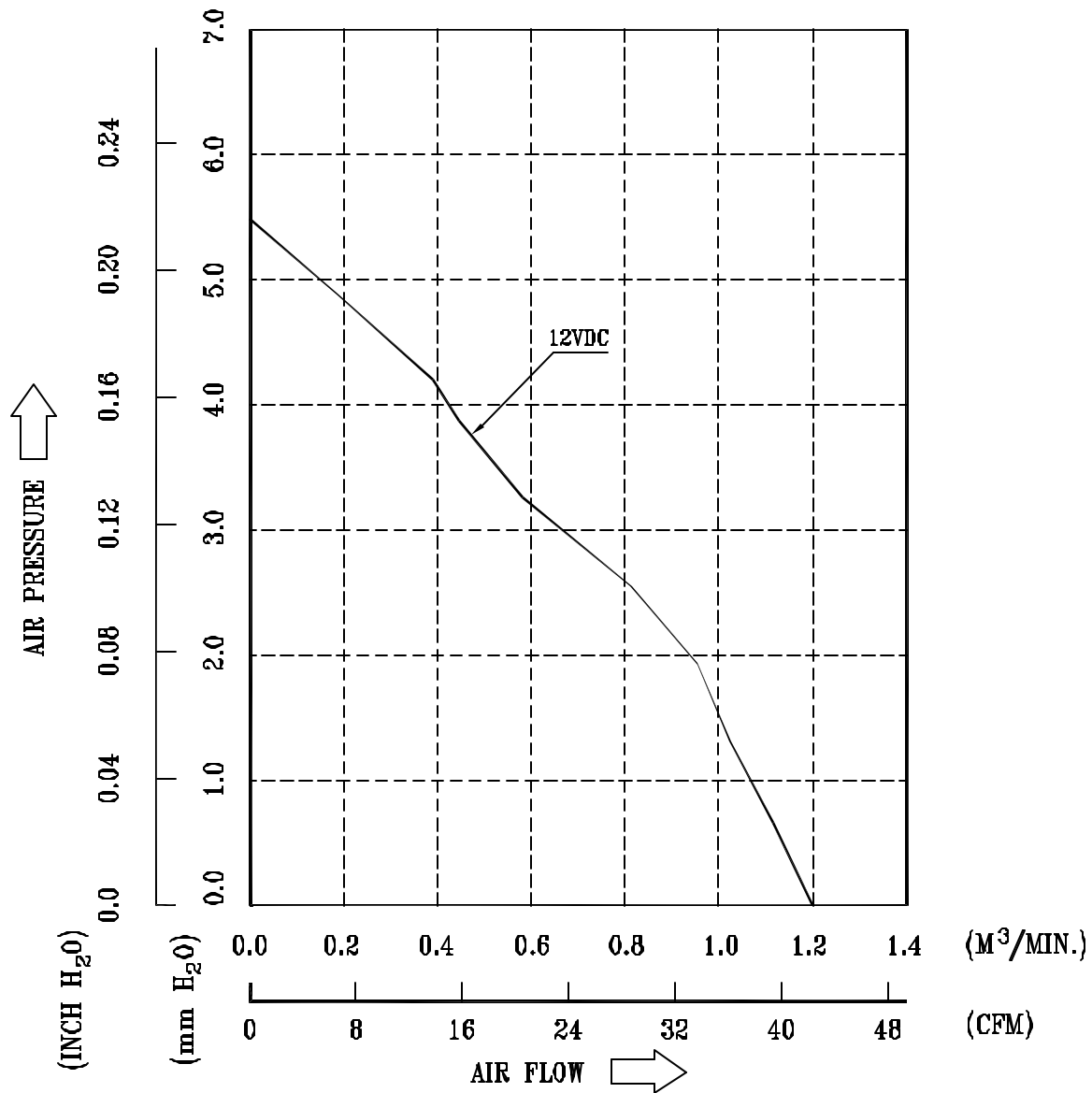

* TEST CONDITION: INPUT VOLTAGE ——— OPERATION VOLTAGE
TEMPERATURE ——— ROOM TEMPERATURE
HUMIDITY ——— 65%RH

PART NO:

DELTA MODEL: AFB0812SHB-F00

10. DIMENSION DRAWING:

LABEL:

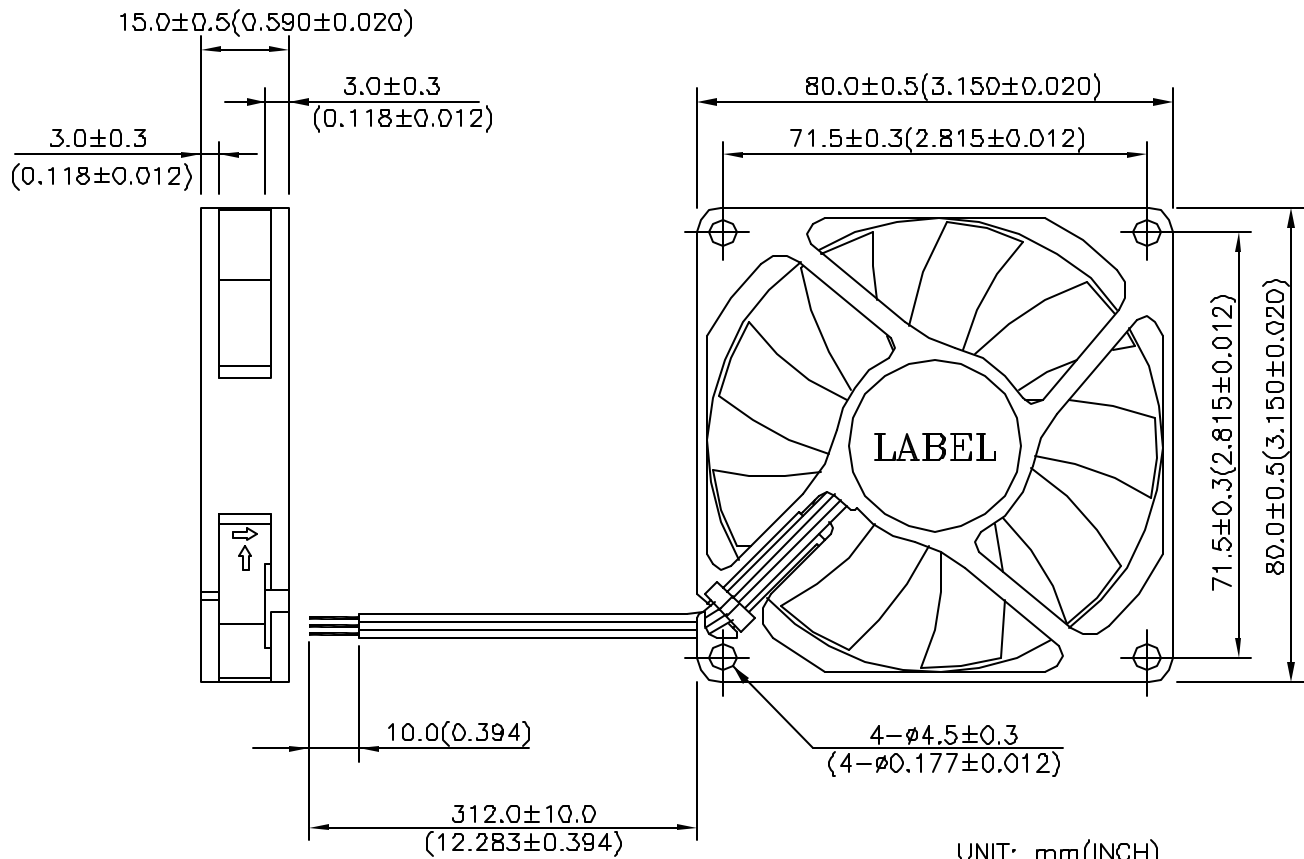
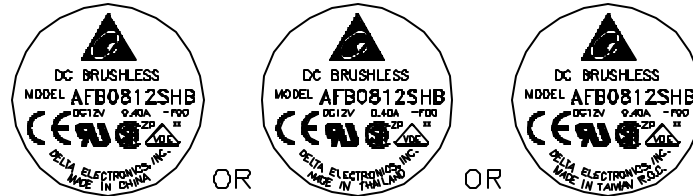

PART NO:

DELTA MODEL: AFB0812SHB-F00

11. FREQUENCY GENERATOR (FG) SIGNAL:

1. OUTPUT CIRCUIT - OPEN COLLECTOR MODE:

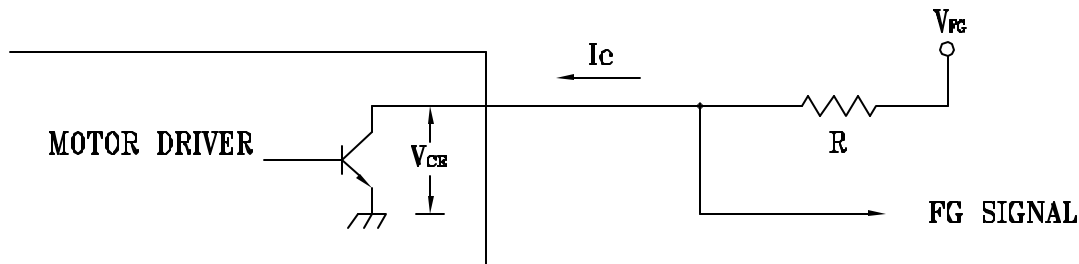

CAUTION:

THE LEAD WIRE OF FG SIGNAL CAN NOT TOUCH THE LEAD WIRE OF POSITIVE OR NEGATIVE.

2. SPECIFICATION:

$V_{ce}(\text{sat}) = 0.5V \text{ MAX.}$

$V_{FG} = 45.0VDC \text{ MAX.}$

$I_c = 5mA \text{ MAX.}$

$R \geq V_{FG} / I_c$

3. FREQUENCY GENERATOR WAVEFORM:

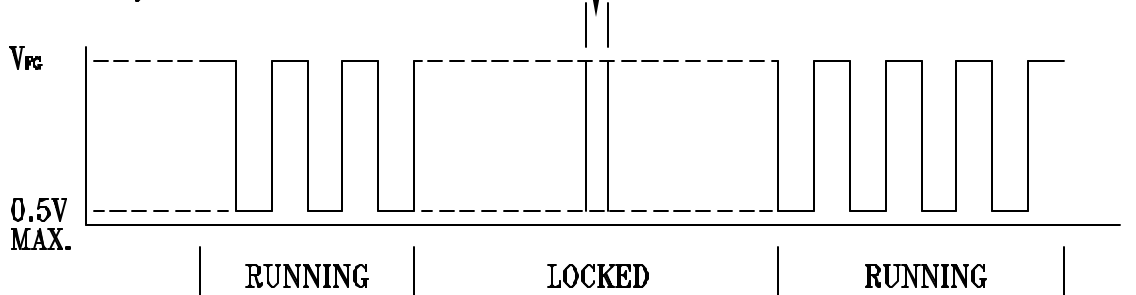

FAN RUNNING FOR 4 POLES

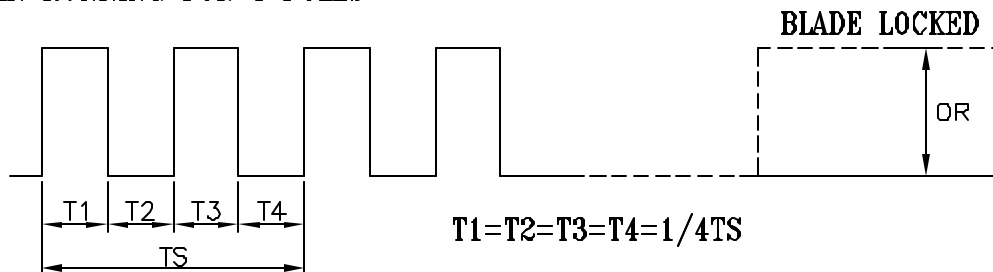

$N = \text{R.P.M}$

$TS = 60/N(\text{SEC})$

*VOLTAGE LEVEL AFTER BLADE LOCKED

*4 POLES



Descriptions:

- 1. Delta will not guarantee the performance of the products if the application condition falls outside the parameters set forth in the specification.**
- 2. A written request should be submitted to Delta prior to approval if deviation from this specification is required.**
- 3. Please exercise caution when handling fans. Damage may be caused when pressure is applied to the impeller, if the fans are handled by the lead wires, or if the fans are hard-dropped to the production floor.**
- 4. Except as pertains to some special designs, there is no guarantee that the products will be free from any such safety problems or failures as caused by the introduction of powder, droplets of water or encroachment of insect into the hub.**
- 5. The above-mentioned conditions are representative of some unique examples and viewed as the first point of reference prior to all other information.**
- 6. It is very important to establish the correct polarity before connecting the fan to the power source. Positive (+) and Negative (-). Damage may be caused to the fans if connection is with reverse polarity, as there is no foolproof method to protect against such error.**
- 7. Delta fans are not suitable where any corrosive fluids are introduced to their environment.**
- 8. Please ensure all fans are stored according to the storage temperature limits specified. Do not store fans in a high humidity environment. We highly recommend performance testing is conducted before shipping, if the fans have been stored over 6 months.**
- 9. Not all fans are provided with the Lock Rotor Protection feature. If you impair the rotation of the impeller for the fans that do not have this function, the performance of those fans will lead to failure.**
- 10. Please be cautious when mounting the fan. Incorrect mounting of fans may cause excess resonance, vibration and subsequent noise.**
- 11. It is important to consider safety when testing the fans. A suitable fan guard should be fitted to the fan to guard against any potential for personal injury.**
- 12. Except where specifically stated, all tests are carried out at relative (ambient) temperature and humidity conditions of 25°C, 65%. The test value is only for fan performance itself.**
- 13. Be certain to connect an “over 4.7 μ F” capacitor to the fan externally when the application calls for using multiple fans in parallel, to avoid any unstable power.**



DELTA ELECTRONICS INC
MR R LU
31-1 SHIEN PAN RD
KUEI SHAN INDUSTRIAL ZONE
TAOYUAN HSIEN TAIWAN

RE: Project Number(s) - 03CA11031

Your most recent Certification is shown below. You may also view this information, or a portion of this information (depending on the product category), on UL's Online Certifications Directory at www.ul.com/database. Please review the text and contact the Conformity Assessment Services staff member who handled your project if revisions are required. For instructions on placing an order for this information in a 3 x 5-inch format, you may refer to the enclosed order form for UL Card Service.

GPWV2
Fans, Electric - Component

June 4, 2003

DELTA ELECTRONICS INC
14TH FL 266 2ND WEN-HWA RD, SEC 1 LINKOU, TAIPEI HSIEN
244 TAIWAN

E132003

Model AFB followed by 0405, 0412, followed by HA, HHA, LA or MA; Model AFB followed by 0505, followed by HB, LB or MB; Model AFB followed by 0512, followed by HB, HHB, LB or MB; Model AFB followed by 0605, followed by H, L or M, followed by R00, R05, RR0 or RR05; Model AFB followed by 0605 or 0805, followed by H, L or M; Model AFB followed by 0612, 0624, followed by EH, SH VH; Model AFB0612LB; Model AFB followed by 0612, 0624, 0812, 0824, 0912 or 0924, followed by H, HB, HH, HHB, LB, LLB, MB, SHB or VHB; Models ASB0412MA, ASB0412LA, ASB0405MA; Model ASB followed by 0405, 0412, followed by HA, HHA, LA or MA; Model ASB followed by 0505, followed by HB, LB or MB; Model ASB followed by 0512, 0524, followed by HB, HHB, LB or MB; Model ASB followed by 0812, 0824, followed by HB, HHB, LB, LLB, MB, SHB or VHB; Model ASB followed by 0612 or 0624, followed by H, HH, L or M; Model ASB followed by 0812, followed by L or M; Model ASB followed by 0912 or 0924, followed by H, L or M; Model AUB followed by 0505, 0512 or 0524, followed by HB, HHB, LB or MB; Model AUB followed by 0612, 0624, followed by H, HH, L or M; Model AUB followed by 0912, 0924, followed by H, HH, L, M or VH; Model AUB followed by 0612 or 0624, followed by L, M, H or HH; Model AUB followed by 0812 or 0824, followed by HB, HHB, LB, LLB, MB, SHB or VHB; Model AUB followed by 0924, followed by L, M, H, HH or VH; Model BFB followed by 1212, followed by H, HH, L, LL, M or VH; Model BFB followed by 1224, followed by H, HH, L, LL, M or VH; Model BFB followed by 1248, followed by H, HH, L, LL, M; Model BFC followed by 1012, followed by A, B or C; Model DFB followed by 0405 or 0412, followed by H, L, LL, M; Model DFB followed by 0612, 0812, 0912, 0824 or 0924 followed by H, L or M; Model DFB followed by 0612, 0812, 0824, 0912 or 0924, followed by HH; Model DFB followed by 0424, followed by H, L, LL, M; Model DFB followed by 0612, 0624, followed by H, HH, L or M; Model DFC followed by 0612, 0812 or 0912, followed by "A" or "B"; Model DFD followed by 0612 or 0624, followed by H, HH, L or M; Model SB followed by 0412, followed by H, L, LL or M; Model SB followed by 0612, 0624, followed by HH; Model SB followed by 0612, 0624, 0812, 0824, followed by H, L or M; Model SB followed by 0612, 0624, followed by HD, LD or MD; Model SB followed by 0812, 0824, followed by HH; Model SB followed by 0812, followed by MSA or MSG.

Model AFB followed by 02505, followed by HA, HHA, LA or MA; Model AFB followed by 02512, followed by HA, HHA, LA or MA; Model AFB followed by 0305, followed by -HA, -LA, -LLA, MA; Model AFB followed by 0312, followed by -HA, LA, LLA, MA; Model AFB followed by 03505, followed by HA, LA, MA; Model AFB followed by 0405, followed by HD, LD or MD; Model AFB followed by 03512, followed by LA, MA or HA; Model AFB followed by 0405, 0412 or 0424, followed by HD, HHD, LD, MD; Model AFB followed by 0412 or 0424, followed by HD, HHD, LD or MD; Model AFB followed by 0505, 0512, followed by HA, LA or MA; Model AFB followed by 0524, followed by HB, HHB, LB or MB; Model AFB followed by 0605, followed by HB, HHB, HD, HHD, LB, LD, LLD, MB or MD; Model AFB followed by 0605, followed by HD, HHD, LD, LLD or MD; Model AFB followed by 0605, followed by HA, LA or MA; Model AFB followed by 0612, followed by HA, HB, HHB, LA, MA or MB; Model AFB followed by 0612 or 0624, followed by HD, HHD, LB, LD, LLD, MD, VHB or VHD; Model AFB followed by 0624, followed by HB, HHB, LB, MB or VHB; Model AFB followed by 0648, followed by EH, H, HH, L, M; SH or VH; Model AFB followed by 0705, followed by H, L or M; Model AFB followed by 0712 or 0724, followed by H, HA, HH, HHA, L, LA, M, MA, VH or VHA; Model AFB followed by 0748, followed by H, HH, L or MM; Model AFB followed by 0805, followed by H, L, LL or M; Model AFB followed by 0805, 0812 or 0824, followed by LL; Model AFB followed by 0812 or 0824, followed by H, L, LL, M, SH or VH; Model AFB followed by 0812 or 0824, followed by HB, HHB, LB, LLB, MB, SHB or VHB; Model AFB followed by 0848, followed by H, HH, L or M; Model AFB followed by 0912 or 0924, followed by H, HH, L, M or VH; Model AFB followed by 0948, followed by H, HH, L or M; Model WFB followed by 1212, followed by ME-RDA; Model WFB followed by 1212, followed by ME; Model WFB followed by 1212, 1224 or



AFB0805H	5	650	STD R00 F00
AFB0805L	5	450	STD R00 F00
AFB0805LL	5	250	STD R00 F00
AFB0805M	5	550	STD R00 F00
AFB0812H	12	240	STD R00 F00
AFB0812HB	12	200	STD R00 F00
AFB0812HH	12	300	STD R00 F00
AFB0812HHB	12	240	STD R00 F00
AFB0812L	12	120	STD R00 F00
AFB0812LB	12	140	STD R00 F00
AFB0812LL	12	100	STD R00 F00
AFB0812LLB	12	110	STD R00 F00
AFB0812M	12	180	STD R00 F00
AFB0812MB	12	170	STD R00 F00
AFB0812L-SB	12	120	-
AFB0812M-SB	12	180	-
AFB0812H-SB	12	240	-
AFB0812SH	12	510	STD R00 F00
AFB0812SHB	12	400	STD R00 F00
AFB0812VH	12	410	STD R00 F00
AFB0812VHB	12	300	STD R00 F00
AFB0824H	24	120	STD R00 F00
AFB0824HB	24	120	STD R00 F00
AFB0824HH	24	150	STD R00 F00
AFB0824HHB	24	150	STD R00 F00
AFB0824L	24	90	STD R00 F00
AFB0824LB	24	80	STD R00 F00
AFB0824LL	24	70	STD R00 F00
AFB0824LLB	24	70	STD R00 F00



VDE Prüf- und Zertifizierungsinstitut

Gutachten mit Fertigungsüberwachung

Ausweis-Nr. /
Licence No. 001764 ÜG

Blatt /
page 7

Name und Sitz des Genehmigungs-Inhabers / Name and registered seat of the Licence holder

Delta Electronics Inc.
186 Ruey Kuang Road
NEIHU TAIPEI (114), Taiwan

Aktenzeichen / File ref.

11641-2611-0001 / 32Y3F F13 / SFK

letzte Änderung / updated

2001-06-05

Datum / Date

1994-06-08

Dieses Blatt gilt nur in Verbindung mit Blatt 1 des Gutachtens mit Fertigungsüberwachung Nr. 001764 ÜG.
This supplement is only valid in conjunction with page 1 of the Licence No. 001764 ÜG.

Jahresgebühren-Einheiten /
Annual fee units

BFB1212LE/ME/HHE(-F00/R00)	DC 12 V	3,00
AFB0605LB/MB/HB	DC 5 V	3,00
AFB0512LB/MB/HB/HHB	DC 12 V	4,00
BFB0505L/M	DC 5 V	2,00
BFB0512L/M/H/HH	DC 12 V	4,00
AFB0605LA/MA/HA	DC 5 V	3,00
AFB03505LA/MA/HA	DC 5 V	3,00
AFB1212SHE	DC 12 V	1,00
AFB1224SHE	DC 24 V	1,00
AFB1248LE/ME/HE/HHE/VHE	DC 48 V	5,00
EFB0512LA/MA/HA	DC 12 V	3,00
AFB0748L/M/H/HH	DC 48 V	4,00
AFB0848L/M/H/HH	DC 48 V	4,00
AFB0948L/M/H/HH	DC 48 V	4,00
AFC0824A/B	DC 24 V	2,00
AFC0924A/B	DC 24 V	2,00
AFB03512LA/MA/HA	DC 12 V	3,00
BFB1212HH/VH	DC 12 V (neue Ausführung / new design)	2,00
BFB1224HH/VH	DC 24 V (neue Ausführung / new design)	2,00
BFB1248LL/L/M/H/HH	DC 48 V	5,00
AFB0605L/M/H-R00	DC 5 V	3,00
AFB0605L/M/H-R05	DC 5 V	3,00
AFB0605L/M/H-RR0	DC 5 V	3,00
AFB0605L/M/H-RR05	DC 5 V	3,00
BFB0405LE/ME/HE	DC 5 V	3,00
BFB0412LE/ME/HE/HHE	DC 12 V	4,00
BFB1612L/M/H	DC 12 V	3,00
BFB1624L/M/H	DC 24 V	3,00
BFB1648L/M	DC 48 V	2,00
AFB0648L/M/H/HH	DC 48 V	4,00
AFB0405HHD	DC 5 V	2,00
AUB0812L/M/H/HH/VH	DC 12 V	4,00
AUB0824L/M/H/HH/VH	DC 24 V	4,00
AFB02505HHA	DC 5 V	2,00
EFB1212LE/ME/HE/HHE/VHE/SHE	DC 12 V	6,00
EFB1224LE/ME/HE/HHE/VHE/SHE	DC 24 V	6,00
EFB1248LE/ME/HE/HHE/VHE/SHE	DC 48 V	6,00
AFB0812LLB/LB/MB/HB/HHB/VHB/SHB	DC 12 V	7,00
AFB0824LLB/LB/MB/HB/HHB/VHB/SHB	DC 24 V	7,00
AFC0812C	DC 12 V	1,00

Fortsetzung siehe Blatt 8 /